



TRUE RESIDENTIAL®

15 INCH TRUE ICE® MACHINE INSTALL GUIDE AND USER'S MANUAL



PRESERVE THE MOMENT®



829867

THANK YOU

FOR YOUR PURCHASE



PRESERVE THE MOMENT®

LUXURY REFRIGERATION WITH COMMERCIAL DNA



CONTENTS

INSTALLATION CHECKLIST **6**

15 INCH TRUE ICE® MACHINE MODELS **7**

SAFETY INFORMATION & OWNERSHIP

FEATURES OF THE TRUE ICE® MACHINE **10**

OWNERSHIP **11**

REFRIGERANT SAFETY & WARNING
INFORMATION **11**

SAFETY LABELS & LOCATIONS **11**

BASIC SAFETY PRECAUTIONS & WARNINGS **13**

PROPER DISPOSAL OF THE CABINET **13**

CABINET LOCATION & SPECIFICATIONS **14**

CONTACT US **14**

OUTDOOR USE **14**

PRIOR TO INSTALLATION

ROUGH OPENING **16**

ANTI-SWEAT FOAM END PANELS **16**

WATER LINE, DRAIN LINE, AND POWER CORD
LOCATIONS **16**

PLAN VIEWS **17**

CUSTOM PANEL SPECIFICATIONS **19**

CUSTOM PANEL INSTALLATION **20**

ELECTRICAL INSTALLATION & SAFETY **22**

DRAIN CONNECTION **23**

WATER SUPPLY **25**

INSTALLATION

UNCRATING **28**

LEVELING LEGS **29**

LEVELING **29**

KICKPLATE INSTALLATION **29**

WATER FILTER INSTALLATION **30**

CONTENTS

CABINET SETUP

ICE SCOOP **32**

90° DOORSTOP INSTALLATION
(OPTIONAL ACCESSORY) **32**

CABINET OPERATION

BEFORE OPERATING **34**

BREAKER RESET **34**

POWER SEQUENCE **34**

ICE MAKING SEQUENCE **35**

ELECTRONIC CONTROL OPERATION **36**

MAINTENANCE, CARE, & CLEANING

GENERAL MAINTENANCE **44**

WATER FILTER REPLACEMENT **45**

CONDENSER COIL CLEANING **46**

STAINLESS STEEL EQUIPMENT CARE AND
CLEANING **47**

DESCALING & SANITIZING **49**

INTERIOR COMPONENTS **51**

WINTERIZING **54**

SERVICING, REPLACING COMPONENTS & ADJUSTMENTS

SERVICING & REPLACING COMPONENTS **56**

REVERSING DOOR **56**

DOOR ADJUSTMENT **59**

CONTACT US **59**

WARRANTY

LIMITED ICE MACHINE WARRANTY **60**

INSTALLATION CHECKLIST

To ensure no part of the installation process has been overlooked, complete the checklist below.

- Has an authorized True dealer or licensed installer inspected stainless steel surfaces for imperfection?
(Cosmetic defects are covered by a limited 30-day warranty)
- Have all packaging materials been removed?
- Is the unit properly leveled with all leveling legs contacting the floor?
- Has the water filter been installed? Has the water supply been turned on?
- Have the water supply and drain connections been made?
- Is the water supply temperature always between 40-100°F (4.4-7.8°C)?
- Has the ice machine drain line been routed into an open drain with no more than 48" (1,219.2 mm) vertical rise for 1/2" I.D. tubing and no more than 100' (30.48 m) run?
- Has the water supply been turned on?
- Is the power cord plugged into a properly grounded three-prong outlet in accordance with all applicable electrical codes?
- Have all connections been checked for water leaks? If not, pour water directly into the ice storage bin to ensure drain pump operation and inspect for leaks.
- Were the ice maker and storage bin disinfected prior to use? If not, see "Sanitizing" (page 50).
- Has the ice machine been turned on? During the initial fill, can you hear the water valve turn on and see water filling the reservoir tank?
- After the first ice cycle, did all 24 ice cubes fall into the bin during harvest?
- Have the first two batches of ice been discarded?
- Has the customer reviewed the unit's operation in this manual?
- Has the customer reviewed the schedule of maintenance of the machine?

15 INCH TRUE ICE® MACHINE MODELS

15" STAINLESS STEEL



TUI-15-R-SS-D
TUI-15-L-SS-D

15" OVERLAY PANEL



TUI-15-R-OP-D

15" CUSTOM FINISH



TUI-15-R/L-OP-D-DSK-103-H08

CUSTOMIZE YOUR TRUE WITH
A VARIETY OF FINISH AND
HARDWARE OPTIONS AT

<https://true-residential.com/custom/>

FINISH



HARDWARE



FEATURES OF THE TRUE ICE® MACHINE

OWNERSHIP

REFRIGERANT SAFETY & WARNING INFORMATION

SAFETY LABELS & LOCATIONS

BASIC SAFETY PRECAUTIONS & WARNINGS

PROPER DISPOSAL OF THE CABINET

CABINET LOCATION & SPECIFICATIONS

CONTACT US

OUTDOOR USE



PRESERVE THE MOMENT®

FEATURES OF THE TRUE ICE MACHINE

- Produces up to 85 lb (38.5 kg) of ultra-clear gourmet ice cubes per day.
- Stores 28 lb (12.7 kg) of ice cubes.
- Precision Ice-Size control for adjusting to the perfect cube size.
- *Time-of-Flight* technology allows for adjusting the ice level with the push of a button.
- Three-Character LED display tells you what your machine is doing.
- Auto-clean sequence for walk-away cleaning simplicity.
- Cleaning time remaining shown on the display.
- Drain Pump standard on all models.
- Built-in water filter with automatic filter change reminders.
- Fourteen-Color LED bin light.
- High quality True magnetic ice scoop.
- Advanced diagnostics for safe reliable operation.
- Reversible Soft-Close hinges for installation flexibility.
- U.L. approved for outdoor use.
- Industry-leading True Warranty.



PERFORMANCE SPECIFICATIONS

*Max Ice Production	85 lb (38.5 kg) / day
**Rated Ice Production	75 lb (34 kg) / day
**Rated Water Consumption	25 gal / 100 lb
**Rated Electrical Consumption	6.95 kWh / 100 lb

*Performance rated at 70°F (21.1°C) air / 50°F (10°C) water / 30 psig (206.8 kPa) water pressure

**Performance rated at 90°F (32.2°C) air / 70°F (21.1°C) water / 30 psig (206.8 kPa) water pressure

OWNERSHIP

To ensure that your unit works properly from the first day, it must be installed properly. We highly recommend a trained refrigeration mechanic and electrician install your True equipment. The cost of a professional installation is money well spent.

Before you start to install your TRUE unit, carefully inspect it for freight damage. If damage is discovered, immediately file a claim with the delivery freight carrier.

TRUE is not responsible for damage incurred during shipment.

For any questions about installation, please contact your True dealer or True Residential Technical Service at **844-746-9423** or **TrueResidentialService@TrueMfg.com**. Please have your model and serial number available.

WARNING – PROPER INSTALLATION REQUIRES A CONNECTION TO THE WATER SUPPLY, A DRAIN, AND A DEDICATED ELECTRICAL CIRCUIT. THESE CONNECTIONS ARE THE RESPONSIBILITIES OF THE INSTALLER. IMPROPER CONNECTIONS CAN RESULT IN PERSONAL INJURY, PROPERTY DAMAGE AND IMPROPER OPERATION. THE ICE MACHINE MUST BE INSTALLED ACCORDING TO ALL APPLICABLE NATIONAL, STATE AND LOCAL CODES AND REGULATIONS.

REFRIGERANT SAFETY & WARNING INFORMATION

This unit contains hydrocarbon refrigerant (R-290). Please carefully and completely read all safety labels and the warnings below:



DANGER – Risk of fire or explosion. Flammable refrigerant used. DO NOT use mechanical devices to defrost refrigerator. DO NOT puncture refrigerant tubing; follow handling instructions carefully. To be repaired only by trained service personnel.



DANGER – Risk of fire or explosion (flammable refrigerant used), consult repair manual/owner’s guide before attempting to service this product. All safety precautions must be followed. Dispose of properly in accordance with local and federal regulations. Follow all safety precautions.



CAUTION – Keep all ventilation openings clear of obstruction in the appliance enclosure or in the structure housing the appliance.

SAFETY LABELS & WARNING

Your new ice maker has labels placed in specific locations throughout the cabinet which identify important safety information. Please take a moment to familiarize yourself with the content and label locations.

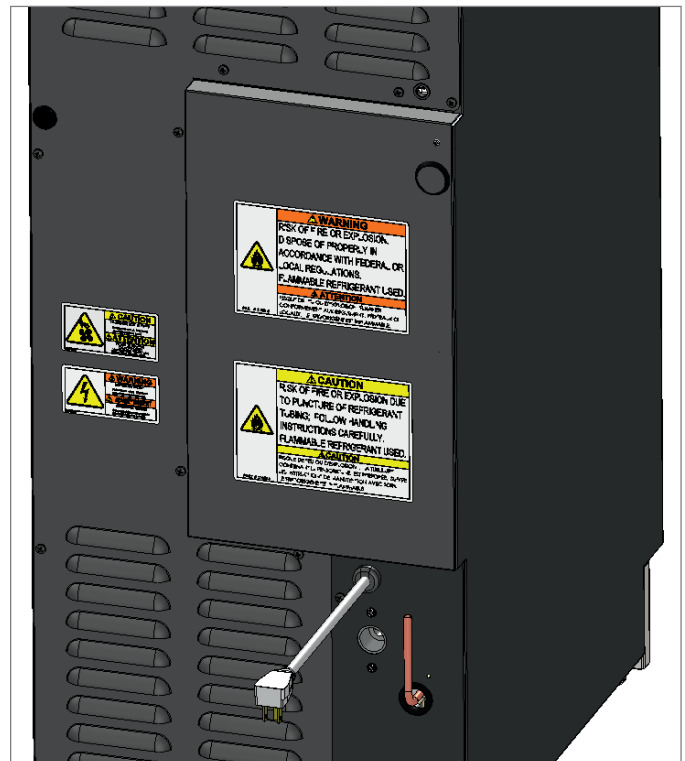



FIG. 1. Example of safety label locations. Not all labels or locations shown.

ON THE REAR PANEL

	⚠ WARNING
	RISK OF FIRE OR EXPLOSION. DISPOSE OF PROPERLY IN ACCORDANCE WITH FEDERAL OR LOCAL REGULATIONS. FLAMMABLE REFRIGERANT USED.
	⚠ ATTENTION
	RISQUE DE FEU OU D'EXPLOSION. ÉLIMINER CONFORMÉMENT AUX RÈGLEMENTS FÉDÉRAUX OU LOCAUX. LE FRIGORIGÈNE EST INFLAMMABLE.
PART # 224556	

	⚠ CAUTION
	RISK OF FIRE OR EXPLOSION DUE TO PUNCTURE OF REFRIGERANT TUBING; FOLLOW HANDLING INSTRUCTIONS CAREFULLY. FLAMMABLE REFRIGERANT USED.
	⚠ CAUTION
	RISQUE DE FEU OU D'EXPLOSION SI LA TUBULURE CONTENANT LE FRIGORIGÈNE EST PERFORÉE. SUIVRE LES INSTRUCTIONS DE MANUTENTION AVEC SOIN. LE FRIGORIGÈNE EST INFLAMMABLE.
PART # 224558	

	⚠ CAUTION
	HAZARDOUS MOVING PARTS Moving parts can cut. Keep hands clear when panels removed.
	⚠ ATTENTION
	PIÈCES EN MOUVEMENT DANGEREUSES Ils peuvent couper. Tenir les mains à l'écart quand panneaux retirés.
PART # 972946	

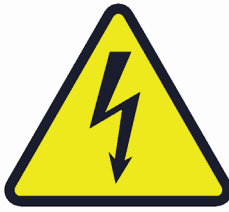
	⚠ WARNING
	HAZARDOUS VOLTAGE Risk of electric shock. Disconnect power before servicing the unit.
	⚠ ADVERTISSEMENT
	DANGEREUX TENSION Débrancher l'alimentation avant de procéder à l'entretien de l'unité.
PART # 972948	

INSIDE THE COMPRESSOR COMPARTMENT

	⚠ DANGER
	RISK OF FIRE OR EXPLOSION. FLAMMABLE REFRIGERANT USED. TO BE REPAIRED ONLY BY TRAINED SERVICE PERSONNEL. DO NOT PUNCTURE REFRIGERANT TUBING.
	⚠ DANGER
	RISQUE DE FEU OU D'EXPLOSION. LE FRIGORIGÈNE EST INFLAMMABLE. CONFIER LES RÉPARATIONS À UN TECHNICIEN SPÉCIALISÉ. NE PAS PERFORER LA TUBULURE CONTENANT LE FRIGORIGÈNE.
PART # 224559	

	⚠ CAUTION
	HAZARDOUS MOVING PARTS Moving parts can cut. Keep hands clear when panels removed.
	⚠ ATTENTION
	PIÈCES EN MOUVEMENT DANGEREUSES Ils peuvent couper. Tenir les mains à l'écart quand panneaux retirés.
PART # 972946	

	⚠ CAUTION
	RISK OF FIRE OR EXPLOSION. FLAMMABLE REFRIGERANT USED. CONSULT REPAIR MANUAL / OWNER'S BEFORE ATTEMPTING TO SERVICE THIS PRODUCT. ALL SAFETY PRECAUTIONS MUST BE FOLLOWED.
	⚠ CAUTION
	RISQUE DE FEU OU D'EXPLOSION. LE FRIGORIGÈNE EST INFLAMMABLE. CONSULTER LE MANUAL DU PROPRIÉTAIRE / GUIDE DE RÉPARATION AVANT DE TENTER UNE RÉPARATION. TOUTES LES MESURES DE SÉCURITÉ DOIVENT ÊTRE RESPECTÉES.
PART # 224555	

BENEATH THE EVAPORATOR COVER'S TOP PANEL

	⚠ DANGER
	RISK OF FIRE OR EXPLOSION. FLAMMABLE REFRIGERANT USED. DO NOT USE MECHANICAL DEVICES TO DEFROST ICE MACHINE. DO NOT PUNCTURE REFRIGERANT TUBING.
	⚠ DANGER
	RISQUE DE FEU OU D'EXPLOSION. LE FRIGORIGÈNE EST INFLAMMABLE. NE PAS UTILISER D'APPAREILS MÉCANIQUES POUR DÉGIVRER LA MACHINE À GLACE. NE PAS PERFORER LA TUBULURE CONTENANT LE FRIGORIGÈNE.
PART # 224557	

BASIC SAFETY & WARNING PRECAUTIONS

- Take care during operation, maintenance or repairs to avoid cuts or pinching from any part/component of the cabinet.
- Units may pose a tipping hazard while uncrating, during installation, or when moving the unit.
- Ensure the unit is properly installed and located in accordance with the Installation Instructions before use.
- This appliance is not to be used, cleaned or maintained by persons (including children) with reduced physical, sensory or mental capabilities or lack of experience and knowledge, unless they have been given supervision or instruction.
- **DO NOT** allow children to play with the appliance or climb, stand, or hang on the unit's shelves to prevent damage to the refrigerator and personal injury.
- **DO NOT** touch the cold surfaces in the freezer compartment when hands are damp or wet. Skin may stick to these extremely cold surfaces.
- Unplug the ice maker before cleaning and making repairs.
- Powering off the ice maker will not remove power from all components (e.g., light circuit and drain pump).
- **DO NOT** store or use gasoline, or other flammable vapors and liquids, in the vicinity of this or any other appliance.
- **DO NOT** store explosive substances such as aerosol cans with a flammable propellant in this appliance.
- Keep fingers out of the "pinch point" areas; clearances between the doors and cabinet are necessarily small; be careful closing doors when children are in the area.

- **DO NOT** use electrical appliances inside the food storage compartments of the units unless the appliances are of the type recommended by the manufacturer.

NOTE: ALL SERVICING MUST BE PERFORMED BY A QUALIFIED TECHNICIAN.

PROPER DISPOSAL OF THE CABINET

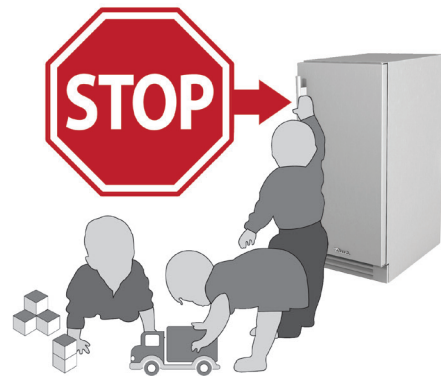

DANGER! RISK OF CHILD ENTRAPMENT

Child entrapment and suffocation are not problems of the past. Junked or abandoned appliances are still dangerous, even if they will sit for "just a few days." If you are getting rid of your old appliance, please follow the instructions below to help prevent accidents.

Before throwing away your old ice machine:

Take off the door.



DANGER – Risk of fire or explosion. Flammable insulation and/or refrigerant used. Dispose of all in accordance with local and federal regulations. Follow all safety precautions.

CABINET LOCATION & SPECIFICATIONS

For more information regarding the installation location or cabinet specifications, please see “Prior to Installation” starting on page 16.

- Appliance is Certified to NSF Standard 12.
- Appliance is UL rated for outdoor use.
- Appliance is not suitable for an area where a pressure washer or hose may be used.
- Ensure the location will provide adequate clearances and sufficient airflow for the cabinet.
- Ensure the power supply for the cabinet matches the cabinet specification sheet or cabinet data plate and is within the rated voltage ($\pm 5\%$) Also, ensure the amperage rating of the circuit is correct and the circuit is properly grounded.
- The cabinet should always be plugged into its own individual dedicated electrical circuit. The use of adapter plugs and extension cords is prohibited.

CONTACT US

For any questions about installation, please contact your TRUE dealer or TRUE Residential Technical Service. Please have your model and serial number (see serial label location below) available so we can better assist you with your service- or parts-related inquiries.

Customer Service

Phone: 888-616-8783
info@true-residential.com

Warranty Department

Phone: 844-849-6179
TrueResidentialWarranty@truemfg.com

Technical Service Department

Phone: 844-746-9423
TrueResidentialService@truemfg.com

SERIAL LABEL LOCATION

Your serial label contains important information such as your model and serial number. The label is located on the upper left interior wall.



OUTDOOR USE

All True undercounter ice machines are rated for outdoor use.

- The unit must be covered or otherwise protected from direct exposure to rain.
- For the safest possible outdoor installation, build the unit into an undercounter kitchenette area within stone, brick, wood, etc.
- If the unit is expected to be exposed to low air temperatures for a prolonged period of time, please turn the unit off and winterize the unit. See “Winterizing” (page 54).

CAUTION: DO NOT ALLOW THE ICE MACHINE TO BE EXPOSED TO TEMPERATURES BELOW 32°F (0°C) WITHOUT WINTERIZING THE UNIT AS THIS WILL CAUSE ANY WATER IN THE MACHINE TO FREEZE. FAILURES CAUSED BY EXPOSURE TO FREEZING TEMPERATURES ARE NOT COVERED BY THE WARRANTY.

ROUGH OPENING

ANTI-SWEAT FOAM END PANELS

WATER LINE, DRAIN LINE, AND POWER CORD LOCATIONS

PLAN VIEWS

CUSTOM PANEL SPECIFICATIONS

CUSTOM PANEL INSTALLATION

ELECTRICAL INSTALLATION & SAFETY

DRAIN CONNECTION

WATER SUPPLY



PRESERVE THE MOMENT®

ALLOWABLE AIR TEMPERATURES

	Air Temperature	Water Temperature	Water Pressure
Minimum	40°F (4.4°C)	40°F (4.4°C)	20 psig (1.4 bar)
Maximum	100°F (37.8°C)	100°F (37.8°C)	80 psig (5.5 bar)

ROUGH OPENING

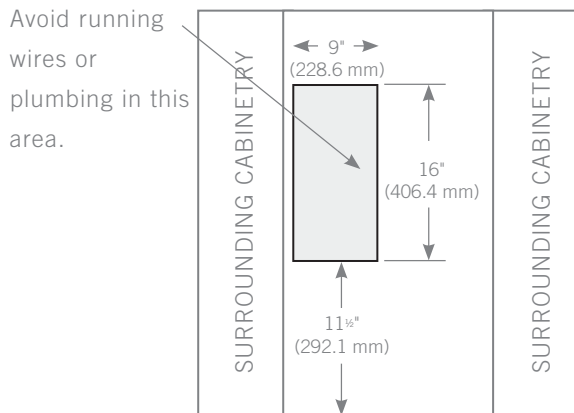
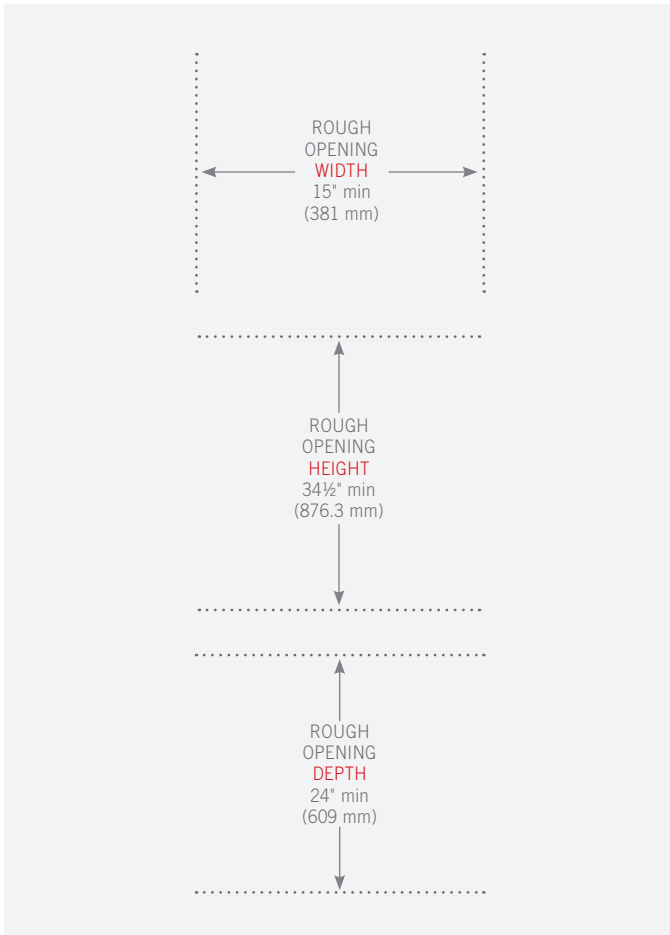

FRONT VIEW OF CABINETRY OPENING

ANTI-SWEAT FOAM END PANELS

When installing two or more True units side-by-side, be sure to leave at least a 5/8" (15.88 mm) gap between the cabinets, or install foam pads between the cabinets and on any side with 0" clearance, to prevent moisture from developing on applications.

If installing anti-sweat foam end panels, True recommends applying a panel to each of the units being joined together. To order foam pads, contact our parts department at **844-849-6226** or **TrueResidentialParts@TrueMfg.com**.

WATER LINE, DRAIN LINE, AND POWER CORD LOCATIONS

The ice maker must be installed with adequate clearance for water and drain connections at the rear of the unit.

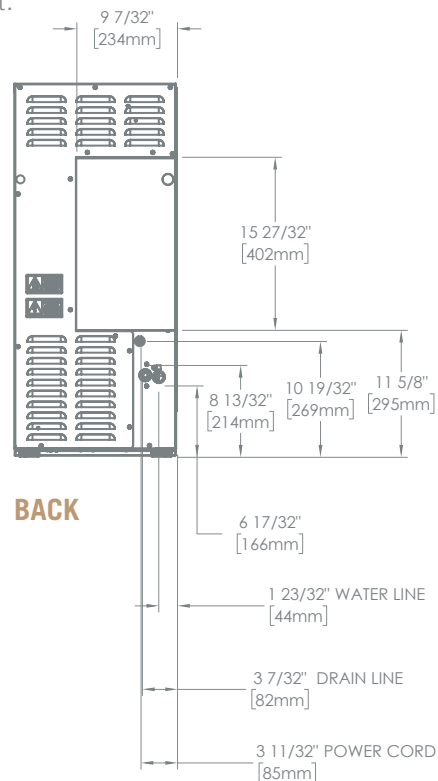

STAINLESS & FINISHED SOLID UNITS

STAINLESS STEEL DOOR



TUI-15-R-SS-D
TUI-15-L-SS-D

CUSTOM FINISH (DSK)



TUI-15-R/L-OP-D-DSK-103-H08

PLAN VIEW DIMENSIONS

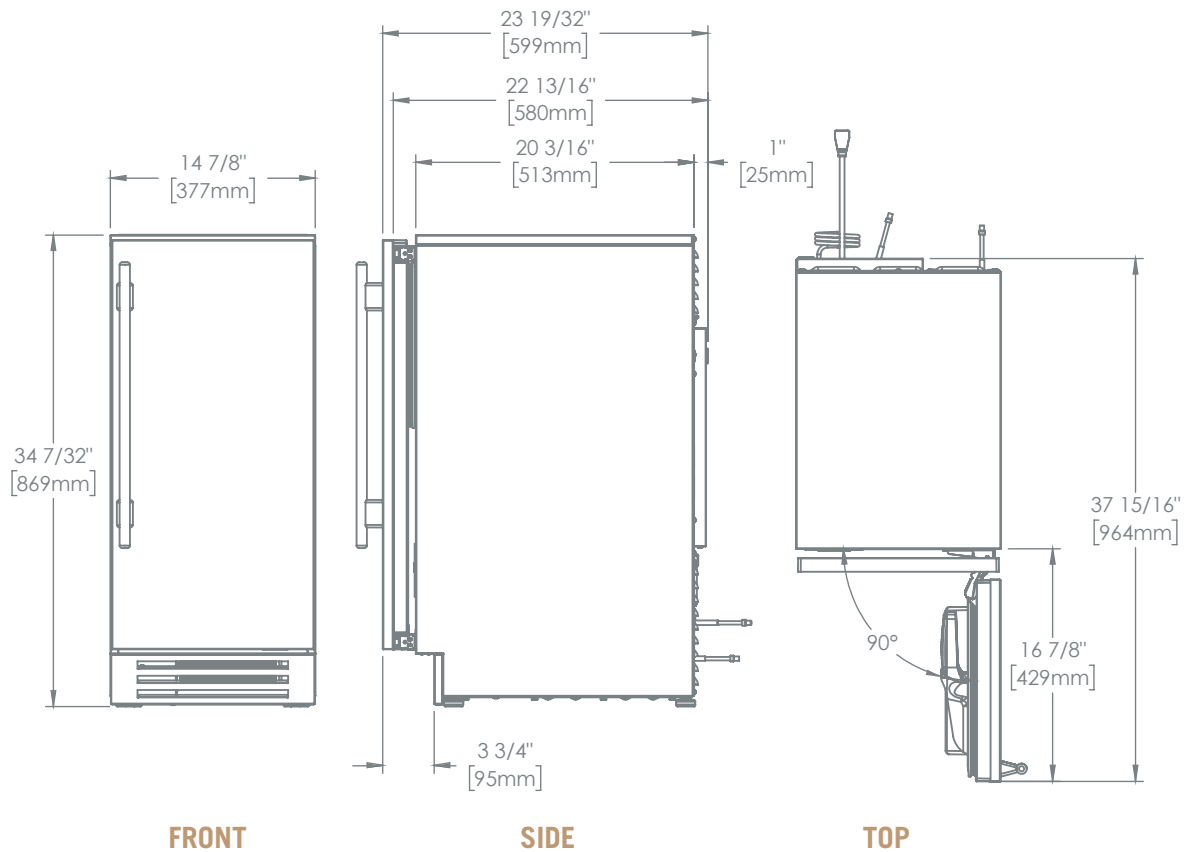

Dimensions may vary by $\pm 1/8$ " (3.2 mm)

SOLID OVERLAY UNITS

SOLID PANEL - READY DOOR (OP)



TUI-15-R-OP-D

TUI-15-L-OP-D

NOTE: Unit shown with overlay panel provided by others.

PLAN VIEW DIMENSIONS

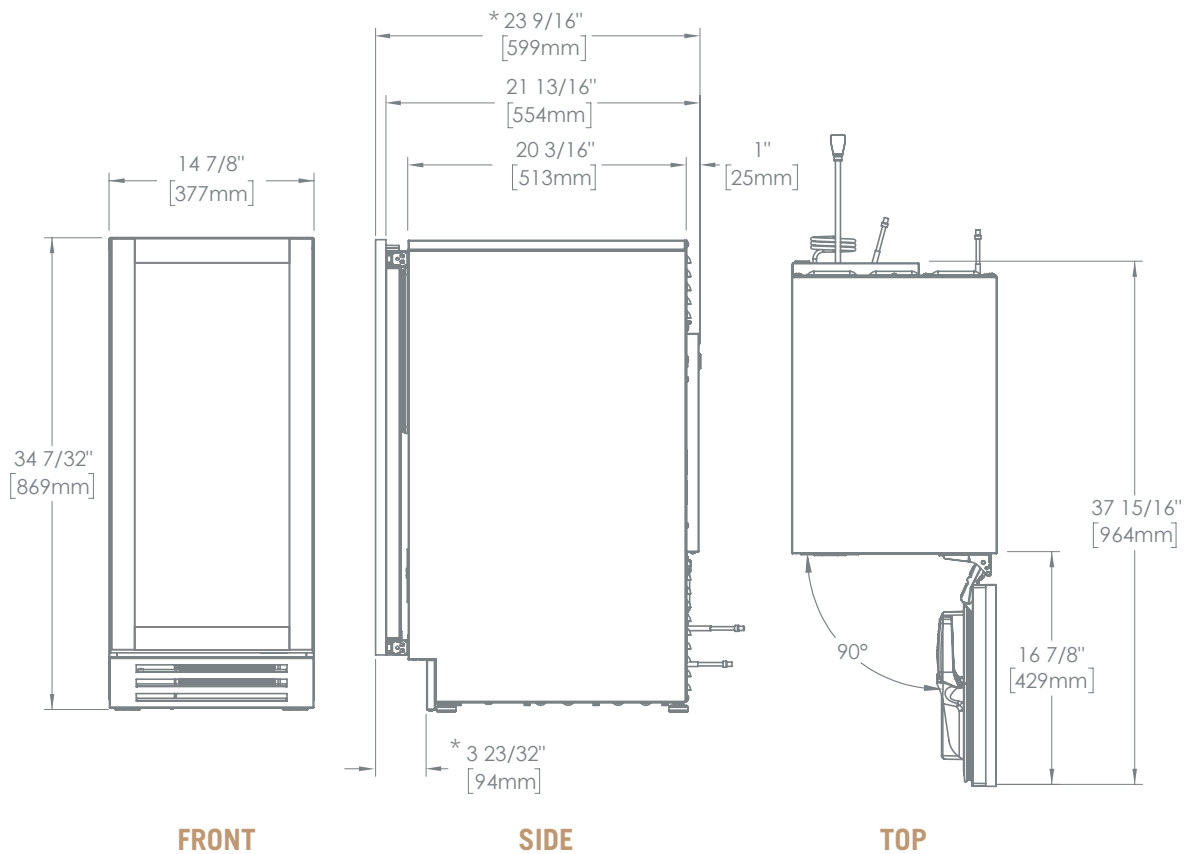

*Measures include 3/4" (19 mm) thick panel (not provided by True)
 Dimensions may vary by $\pm 1/8$ " (3.2 mm)

CUSTOM PANEL SPECIFICATIONS

Overlay units can be fitted with custom panels to match adjacent cabinetry. The integrated panel option extends above the door to conceal the hinge assembly to match full overlay cabinet doors.

See the picture below for reference. For installation instructions, please see “Custom Panel Installation”. (page 20).

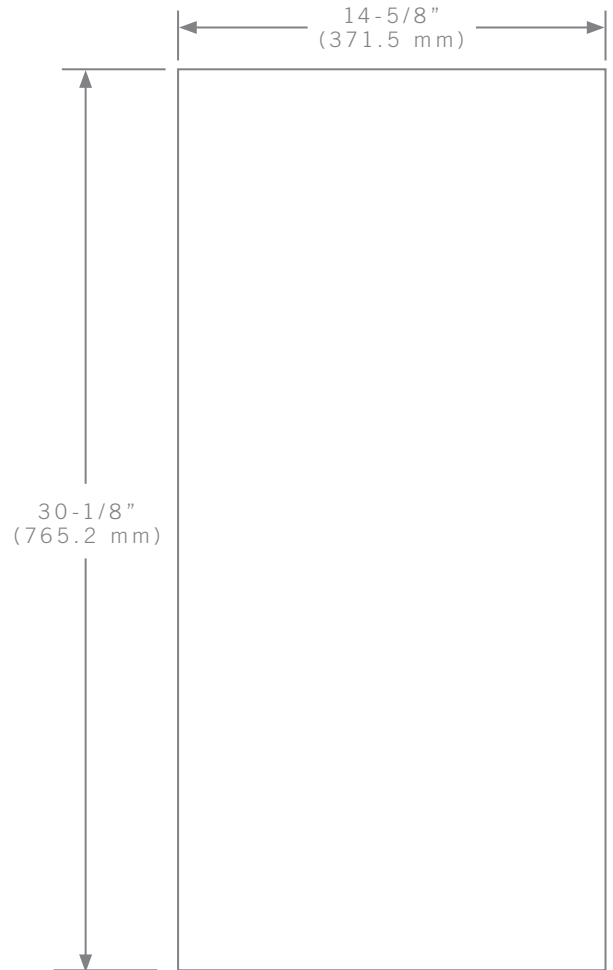

SPECIFICATIONS	
Panel Width	14-5/8" (371.5 mm)
Panel Height	30-1/8" (765.2 mm)
Panel Depth	3/4" (19 mm) max
Panel Weight	20 lb (9.1 kg) max
Rail Style Dimension	2" (50.8 mm) min

CUSTOM PANEL INSTALLATION

Your new ice machine comes with articulating, or soft-closing, hinges. The hinges can be installed on either the left or right to change the direction the door opens. Before installing panels, be sure the door assembly is oriented as desired. See “Reversing Door” (page 56). Please closely read all instructions before installing your panels.

REQUIRED TOOLS

Required tools include (but may not be limited to) the following.

- Surface protection*
- 2+ Clamps ≥ 2” (51 mm)
- 1/8” Hex Head Allen Wrench
- Phillips Screwdriver or Bit Driver
- 1/8” Drill Bit
- (Qty 6) #6 x 1/2” Screws**
- Drill

*Cardboard, moving blanket, foam padding, etc.

**Screw type varies by panel material.

INSTALLATION

1. Carefully lay the door overlay panel face down on a protected surface.

2. With a 1/8” hex head Allen wrench, loosen the cabinet hinge bolts. Then, remove the door. See fig.1.

NOTE: DO NOT REMOVE THE HINGE FROM THE DOOR ASSEMBLY.

3. If NSF Cover is present, carefully pry screw caps from the cover to access the door bracket screws. See fig. 2.

NOTE: THE CAPS ARE INSTALLED WITH A TACKY GLUE THAT CAN BE EASILY REMOVED AND REINSTALLED.

4. Place the door front face down on the overlay panel. Then, align the bottom door bracket’s bottom edge with the overlay panel’s bottom edge. See figs. 3 and 4.
5. Clamp the door assembly panel.

NOTE: IF THE CLAMP JAWS ARE NOT PADDED, INSERT PADDING BETWEEN THE CLAMP AND THE OVERLAY TO PROTECT THE PANEL’S FINISH.
6. If desired, install a handle before proceeding to the next step. For best installation, fasten the handle with recessed screws.
7. With a 1/8” drill bit, carefully drill pilot holes into the door front. See fig. 5.

NOTE: TAKE CARE TO NOT DRILL THROUGH THE FRONT OF THE PANEL.
8. With the appropriate hardware, fasten the overlay panel to the door front. Then, remove the clamps.
9. Install the door assembly. Be sure to fully tighten the hinge screws.
10. Verify the door closes correctly and seals without gaps. Adjust the door as needed; see “Door Adjustment” (page 59).

PRIOR TO INSTALLATION



FIG. 1. Slide the door off the hinge bolts through the keyhole slots.

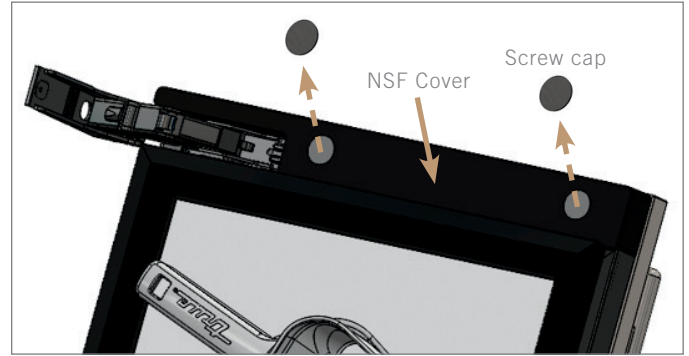

FIG. 2. Remove the NSF cover screw caps.



FIG. 3. Align along the bottom door bracket edge. Front of door assembly shown.

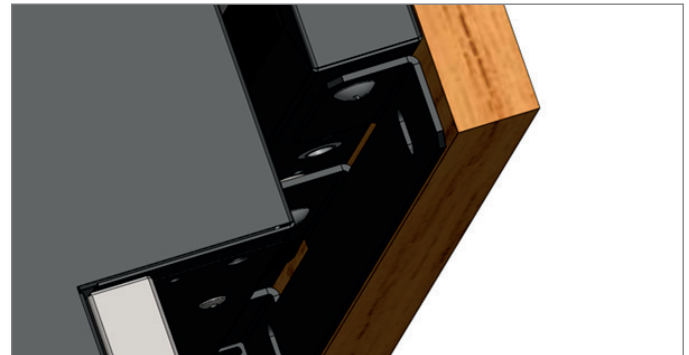

FIG. 4. The bottom edge of the panel should align with the bracket as shown.

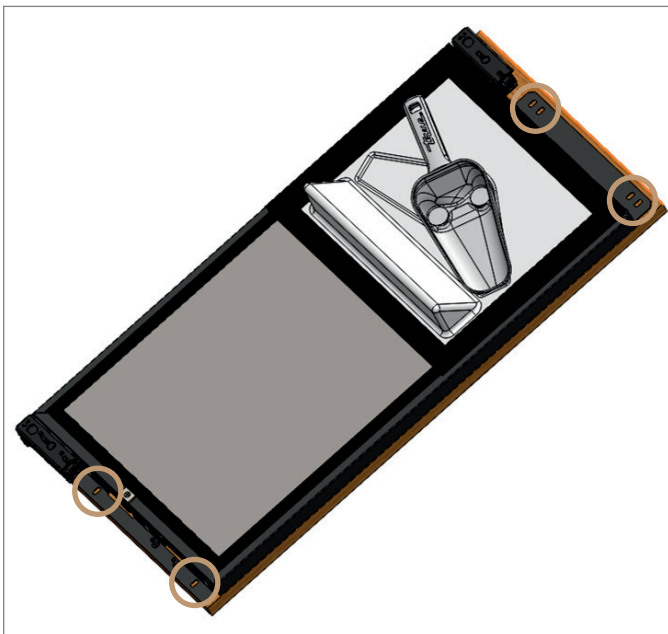

FIG. 5. Carefully fasten the overlay panel to the door front.

ELECTRICAL INSTALLATION & SAFETY

The unit is approved by UL for outdoor installation.

USE OF ADAPTER PLUGS

NEVER USE AN ADAPTER PLUG! An adapter plug alters the original OEM plug configuration when connecting it to a power source.

TRUE will not warranty any refrigerator/freezer that has been connected to an adapter plug.



USE OF EXTENSION CORDS

NEVER USE AN EXTENSION CORD! An extension cord is determined to be any component that adds length to the original OEM power cord when connecting it to a power source.

TRUE will not warranty any refrigerator/freezer that has been connected to an extension cord.



HOW TO CONNECT ELECTRICITY

- The ice maker should always be plugged into a dedicated electrical circuit. This provides the best performance and prevents building wiring circuits from being overloaded, which could cause a fire hazard from overheated wires.
- Before your new unit is connected to a power supply, check the incoming voltage with a voltmeter. If the recorded voltage is less than the rated voltage for operation (+/-5%) and amp rating, correct immediately. Refer to cabinet data plate for this voltage requirement.
- The electrical outlet must be within 36" (914.4 mm) of the center of the back wall of the ice maker's final location. Outlet must be flush with wall and comply with local electrical codes.
- The wall outlet and circuit should be checked by a licensed electrician to make sure the outlet is properly grounded.
- The power cord of this appliance is equipped with a 3-prong (grounding) plug which mates with a standard 3-prong (grounding) wall outlet to minimize the possibility of electric shock hazard from this appliance. A 115V AC, 60 Hz, 15 amp circuit breaker and electrical supply are required.
- If the outlet is a standard 2-prong outlet, it is your personal responsibility and obligation to have it replaced with the properly grounded wall outlet.
- **DO NOT**, under any circumstances, cut or remove the ground prong from the power cord. For personal safety, this appliance must be properly grounded.
- When moving the ice maker, for any reason, be careful not to roll over or damage the power cord.
- Repair or replace immediately all power cords that have become frayed or otherwise damaged. **DO NOT** use a power cord that shows cracks or abrasion damage along its length or at either end.
- If the supply power cord is damaged, it should be replaced with original equipment manufacturer (OEM) components. To avoid hazard this should be done by a licensed service provider.
- **NEVER** unplug your ice maker by pulling on the power cord. Always grip plug firmly and pull straight out from the outlet.

ELECTRICAL OUTLET LOCATION

To minimize the depth of the cutout opening, the electrical outlet must be positioned as shown below. Outlet must be flush with wall.

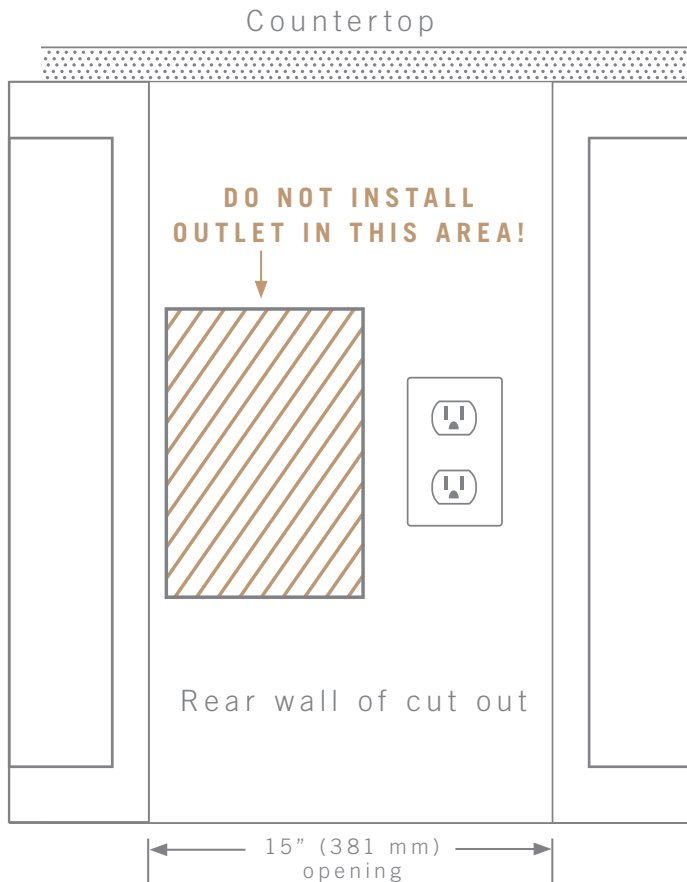

DRAIN CONNECTION

The True Ice® machine has a built-in drain pump.

WARNING: PROPER INSTALLATION REQUIRES CONNECTION TO THE WATER SUPPLY AND A DRAIN. THESE CONNECTIONS ARE THE RESPONSIBILITIES OF THE INSTALLER. TRUE WILL NOT WARRANT LEAKS OR DAMAGE CAUSED BY IMPROPER INSTALLATION. IMPROPER CONNECTIONS CAN RESULT IN PERSONAL INJURY, PROPERTY DAMAGE AND IMPROPER OPERATION. THE ICE MACHINE MUST BE INSTALLED ACCORDING TO ALL APPLICABLE NATIONAL, STATE AND LOCAL CODES AND REGULATIONS.

DO NOT reduce drain connections any smaller than 3/8" I.D.

- 48" (1,219.2 mm) Clear PVC drain hose, 1/2" male NPT connector, and 1/2" hose clamp provided by True
- Using hose larger than 1/2" I.D. may require a larger pump. A check valve may be required to prevent excessive cycling of the drain pump.
- Be sure to use the correct I.D. hose for your vertical rise to ensure the proper flowrate and prevent drain time alarms. For more information, see "Drain Time Alarm" (page 38).
- If the installation requires a **vertical rise greater than 84" (2,133.6 mm)** include an external drain pump to cover the additional required pumping height. Connect the drain tube outlet from the ice maker to the external drain pump inlet. **Do not remove the internal drain pump provided with the ice maker.** Altering the internal components in any way will void the warranty.
- **DO NOT USE HOSE SMALLER THAN 3/8" I.D.**
- The floor drain must be large enough to accommodate additional drainage.
- The drain pump discharge line must terminate at an open site drain.
- Be sure to thoroughly inspect all connections after installation to ensure there are no leaks. Use of thread sealant recommended.

INSTALLATION

1. Thread the 1/2" NPT connector into the drain fitting. See fig. 1.
2. With the clamp on the hose, connect the clear drain hose to the barbed fitting. See fig. 1.
3. Tighten the hose clamp.

NOTE: VERIFY THE ICE MAKER DRAINS THROUGH TWO CYCLES WITHOUT ANY DRAIN ALARM DURING INSTALLATION.

For more information, see "Drain Time Alarm" (page 38).

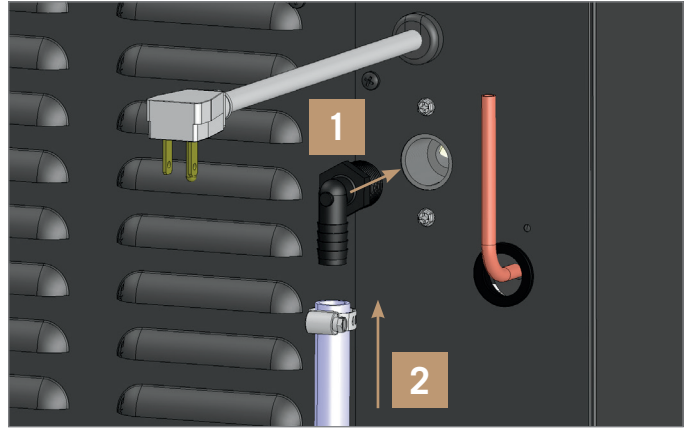
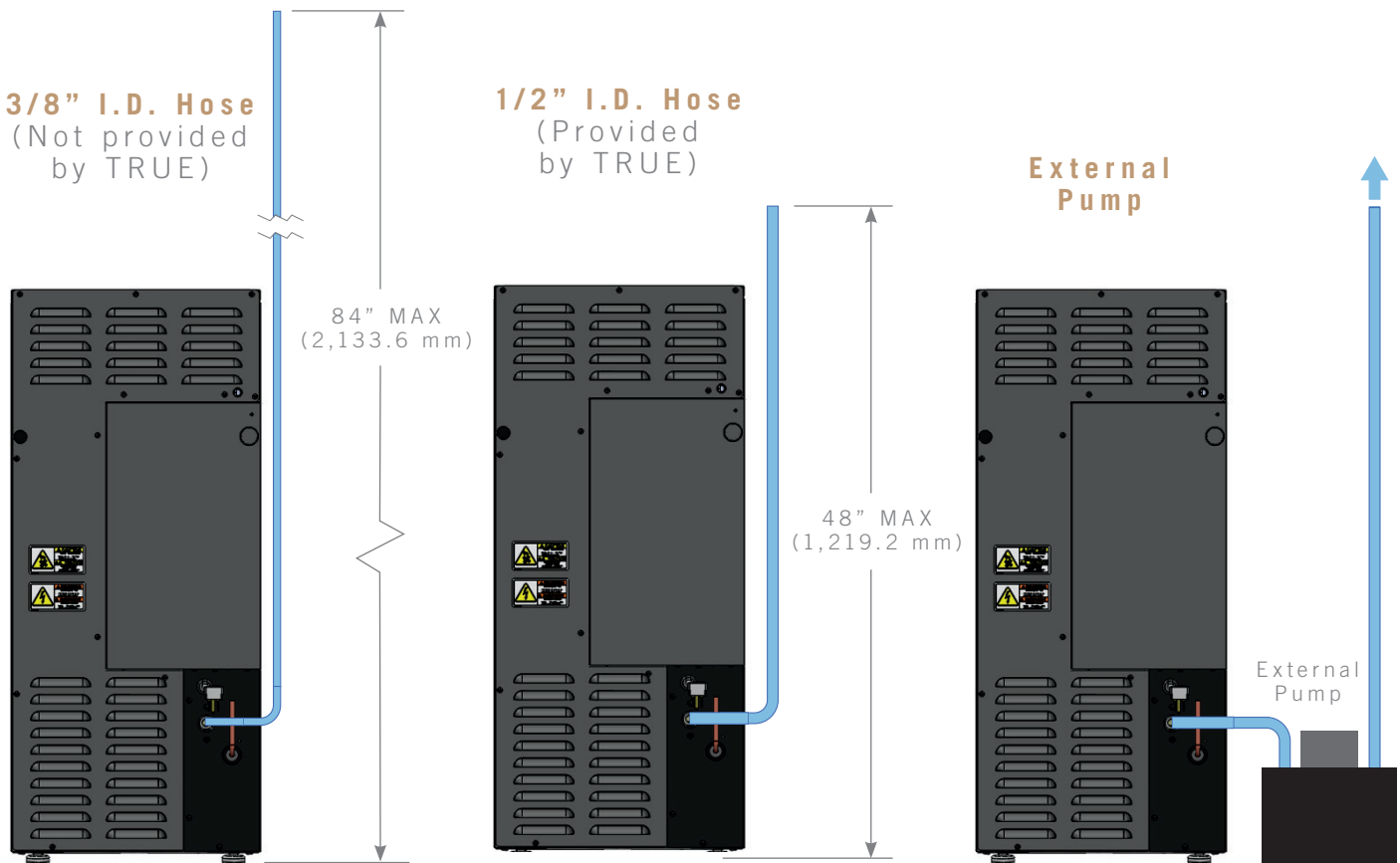

FIG. 1. Be sure to tightly clamp the drain line into the barbed fitting. Thread sealant recommended.

	MAXIMUM VERTICAL RISE	MAX RUN
3/8" I.D. Hose	84" (2,133.6 mm)	100' (30.84 m)
1/2" I.D. Hose (provided by TRUE)	48" (1,219.2 mm)	100' (30.84 m)
Hose larger than 1/2" I.D. may require an external pump.		
Vertical rise higher than 84" will require external pump.		



PRIOR TO INSTALLATION

WATER SUPPLY

- The ice maker comes with a 1/4" O.D. copper tube for connecting the water supply. See fig. 1. for water inlet location.
- Water pressure must be between 20-80 psig (1.4–5.5 bar). If the water pressure exceeds the maximum pressure, install a water pressure regulator.
- A reverse osmosis system can be used if there is **constant water pressure of 20-80 psig (1.4-5.5 bar)**.
- Cold water supply required. Incoming water temperature must remain 40-100°F (4.4-7.8°C).
- Never connect to a hot water supply. Be sure all hot water restrictors installed for other equipment are working, such as check valves on sink faucets, dishwashers, etc.
- Water regulating valve recommended for pressures higher than 80 psig (5.5 bar). If so desired, installing a water hammer valve can reduce the noise and shock from the valve closing.
- Use tight-fitting, leak-proof permanent connections for the water supply. Soldered connections are always best. In the absence of soldering, use compression-type fittings for more reliability.
- While push fittings are acceptable, they are prone to leaks when installed incorrectly and/or not according to the manufacturer's specifications.
- TRUE recommends coiling extra length of supply hose behind the machine to allow proper servicing of the unit. See fig. 1.
- Connect the water supply line to the house supply with an easily accessible shut-off valve in your installation. See fig. 1.
- Insulate the supply line to prevent condensation.
- When switching to PEX, the tubing must be rated for 150 psi (10.3 bar) burst pressure minimum and 180°F (82.2°C).

	WATER TEMPERATURE	WATER PRESSURE
Minimum	40°F (4.4°C)	20 psig (1.4 bar)
Maximum	100°F (37.8°C)	80 psig (5.5 bar)

PLUMBING MATERIAL	
Water Supply	<ul style="list-style-type: none"> • 1/4" O.D. copper • braided stainless steel • PEX tubing and compression fittings (1/4" lines and fittings not provided by TRUE)
Drain Connection	1/2" O.D. Female NPT Fitting (see fig. 1.)

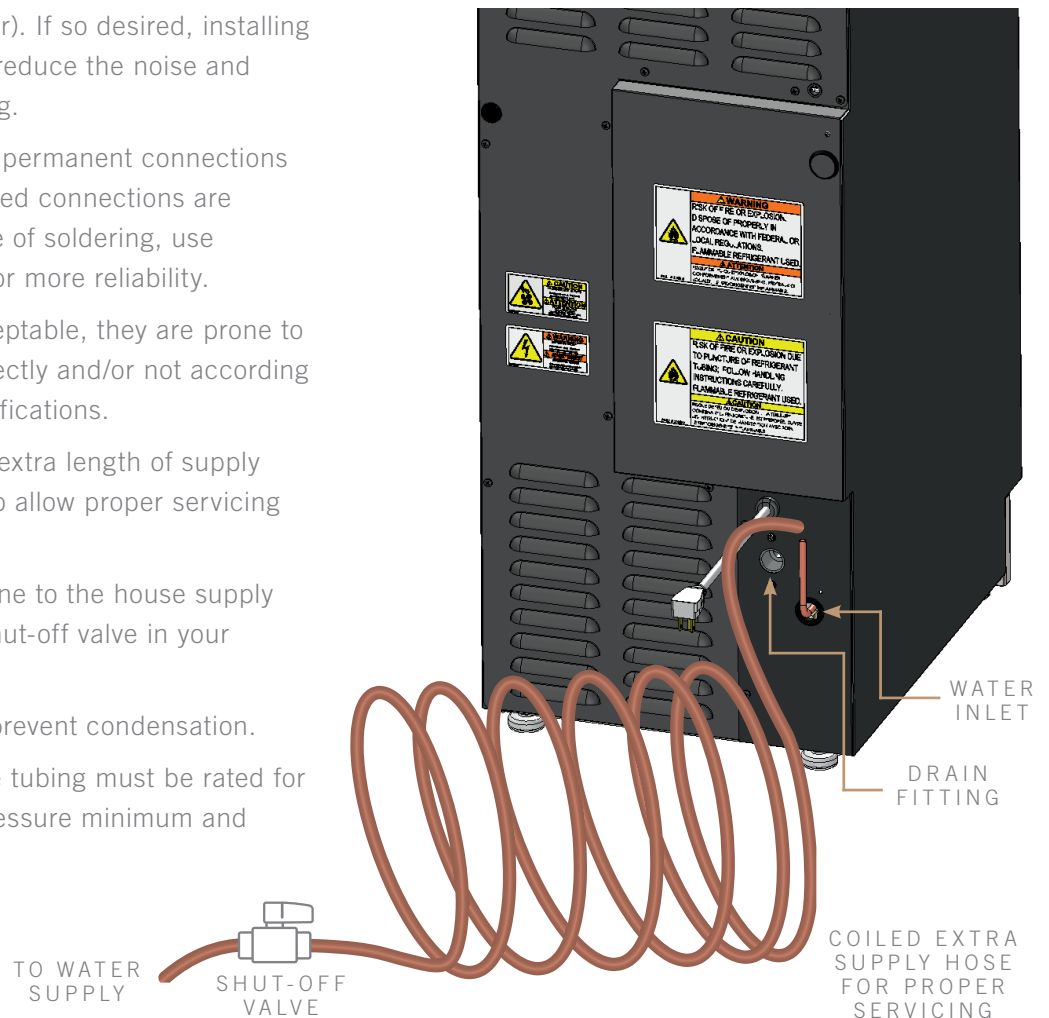

FIG. 1. Example of a water supply installation.

UNCRATING

LEVELING LEGS

LEVELING

KICKPLATE INSTALLATION

WATER FILTER INSTALLATION



PRESERVE THE MOMENT®

UNCRATING

REQUIRED TOOLS

- Cutting Tool
- Hammer
- Crowbar
- Phillips Screwdriver
- Floor Protector

PROCEDURE

The following procedure is recommended for uncrating the unit:

1. Remove the outer packaging (cardboard and clear plastic). See fig. 1.
2. Inspect the unit for concealed damage. **Immediately file a claim with the freight carrier if there is damage.**
3. Cut the plastic band and remove the foam block. See fig. 2.

NOTE: MOVE THE UNIT AS CLOSE AS POSSIBLE TO ITS FINAL LOCATION BEFORE REMOVING THE SKID.

4. Position the floor protector next to the skid.
5. Carefully lift the unit off the skid and place the unit on the floor protector. See fig. 3.
6. Remove the interior packaging.



FIG. 1. Pull the staples from the skid.

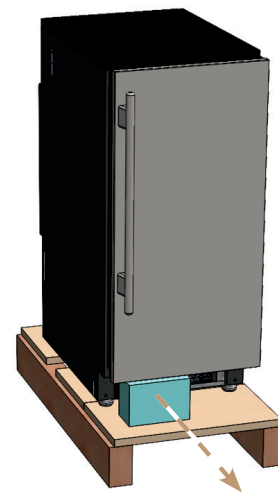

FIG. 2. Remove the foam block after moving the unit as close as possible to the final installation location.

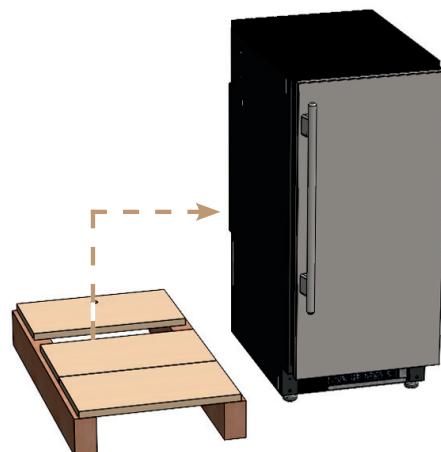

FIG. 3. Carefully move the unit off the skid.

LEVELING LEGS

PROCEDURE

With access to the bottom of the cabinet, turn the leveling legs to adjust the level as needed. See figs. 1 and 2.

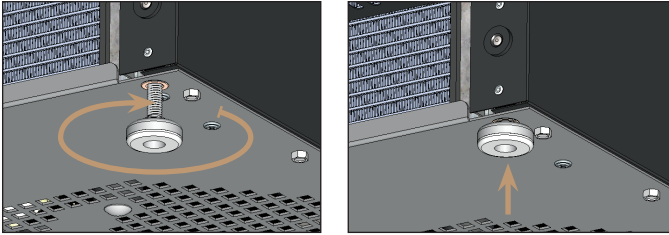

FIG. 1. Turn the leveling legs clockwise to lower the unit.

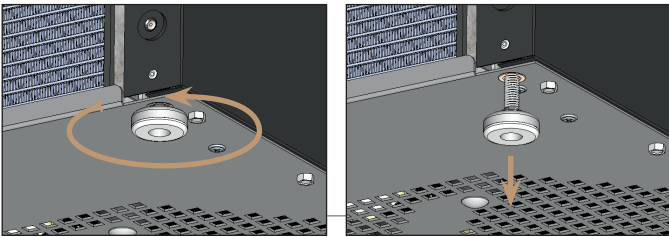

FIG. 2. Turn the leveling legs counterclockwise to raise the unit.

LEVELING

Proper leveling of your ice maker is critical to operating success. Leveling effects drainage and door operation.

PROCEDURE

1. Set the unit in its final location. Be sure there is adequate ventilation in your room.
2. Verify the unit's level. On the unit's top, check the level front-to-back and side-to-side. See fig. 1.
3. Turn the leveling legs as needed to adjust the level. See "Leveling Legs" (page 29).

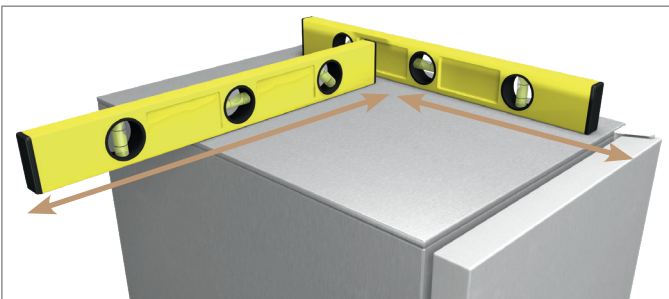

FIG. 1. Check the level from the top of the unit.

KICKPLATE INSTALLATION

The kickplate is shipped unattached to the unit to allow easy access for levelling. The kickplate attaches to the unit with magnets at the bottom of the unit.

INSTALLATION

1. After leveling the unit, position the kickplate below the door. See figs. 1 and 2.
2. Verify the kickplate is correctly aligned. Adjust as needed.

REMOVAL

Pull the kickplate away from the unit.

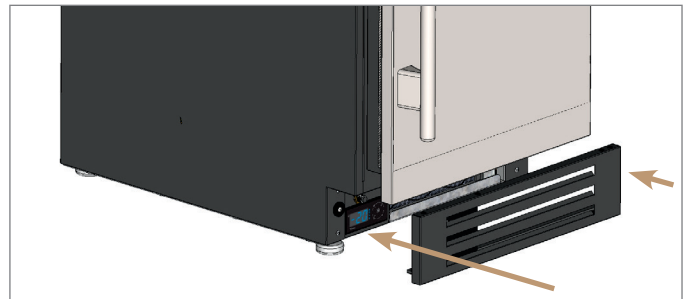

FIG. 1. Attach the kickplate to the magnets below the door.

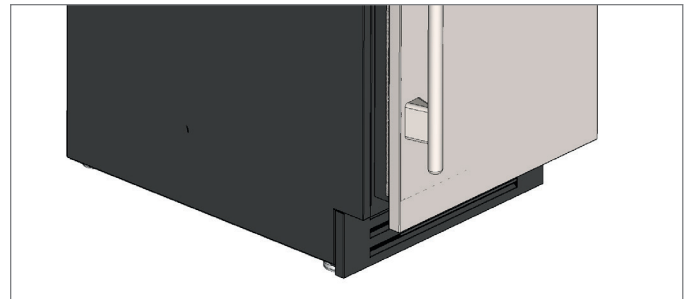

FIG. 2. Adjust the kickplate as needed.

WATER FILTER INSTALLATION

The built-in water filter removes any unpleasant taste/odor, as well as inhibiting scale. The filter life expectancy is 12 months for low-scale water and 6 months for high-scale water. The ice maker monitors how long the filter has been in operation; the display will show **rtr** when the filter needs to be replaced. See water filter replacement instructions on page 45.



CAUTION – Install the water filter before turning on the water supply to the machine. **DO NOT** install the water filter while the water supply is pressurized.

Always relieve the water pressure before changing the filter.

CAUTION: DO NOT ALLOW THE ICE MACHINE TO BE EXPOSED TO TEMPERATURES BELOW 32°F (0°C) WITHOUT WINTERIZING THE MACHINE AS THIS WILL CAUSE ANY WATER IN THE MACHINE TO FREEZE. FAILURES CAUSED BY EXPOSURE TO FREEZING TEMPERATURES ARE NOT COVERED BY THE WARRANTY.

To order a replacement water filter, go to <https://store.trueresidential.com/collections/maintenance-1> or contact our parts department at **844-849-6226** or TrueResidentialParts@TrueMfg.com.

INSTALLATION

1. Align the filter with the filter head's teeth inside the machine. See fig. 1.
2. Insert the water filter and rotate the water filter clockwise. See figs. 1–3.

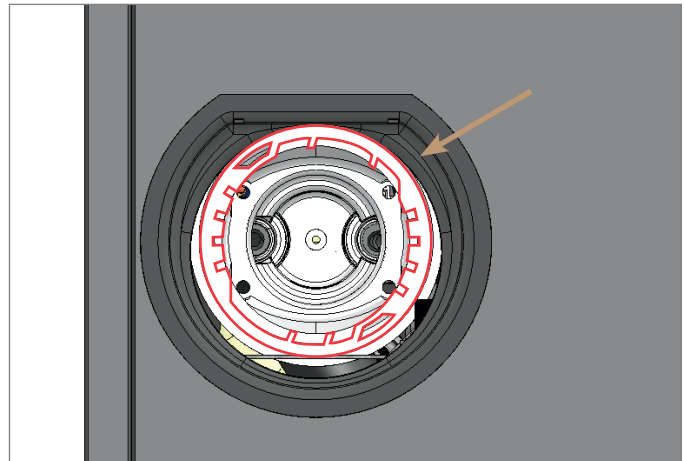

FIG. 1. Teeth inside the filter head.

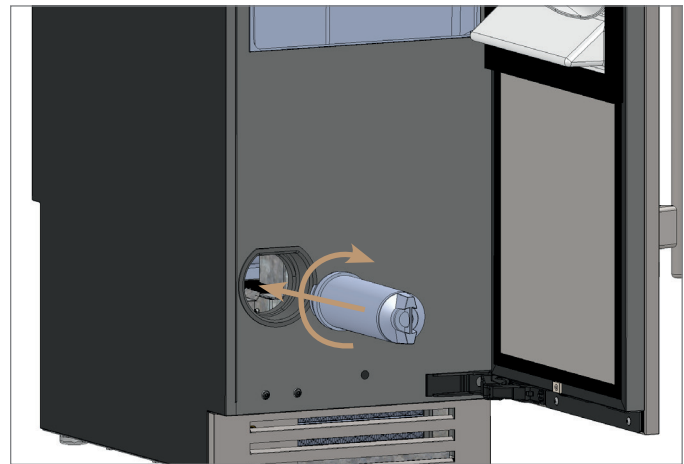

FIG. 2. Insert the water filter and rotate it clockwise.



FIG. 3. Installed water filter.

ICE SCOOP

90° DOORSTOP INSTALLATION (OPTIONAL ACCESSORY)



PRESERVE THE MOMENT®

ICE SCOOP

For easy storage, position the ice scoop on the door's interior. See fig. 1.

1. Orient the door as desired. See "Reversing Door". (page 56).
2. Locate the ice scoop in the interior packaging.
3. Position the ice scoop on the door's interior. See fig. 1.

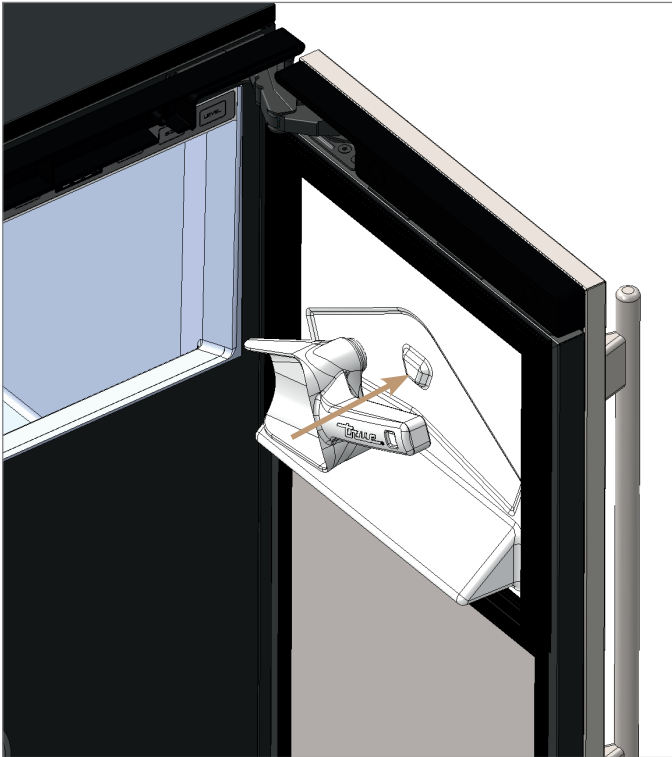

FIG. 1. Attach the ice scoop to the door.

90° DOORSTOP INSTALLATION (OPTIONAL ACCESSORY)

The doorstop restricts the door from opening past approximately 90° to prevent damage to surrounding cabinets.

NOTE: BE SURE TO PUT A DOORSTOP PIN IN BOTH THE TOP AND BOTTOM HINGES. SEE FIGS. 1 AND 2.

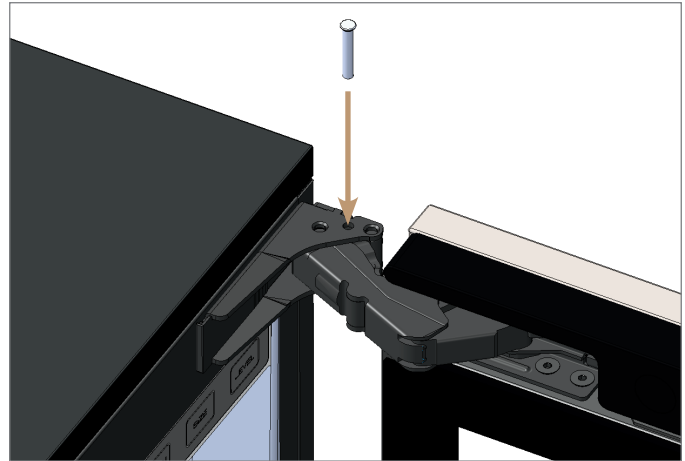

FIG. 1. Drop the doorstop pin into the articulated hinge.

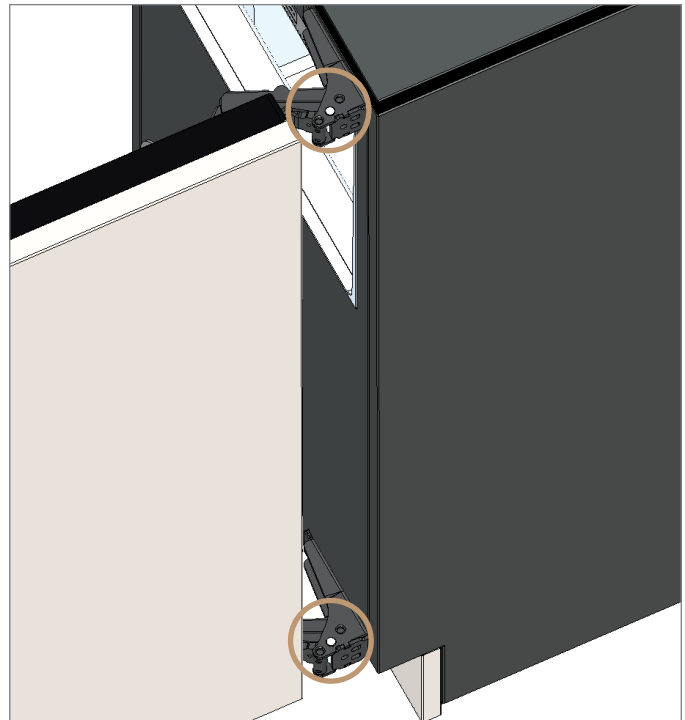

FIG. 2. Install a doorstop pin in both hinges.

BEFORE OPERATING

BREAKER RESET

POWER SEQUENCE

ICE MAKING SEQUENCE

ELECTRONIC CONTROL OPERATION



PRESERVE THE MOMENT®

BEFORE OPERATING

To ensure ice quality, please clean and sanitize this machine prior to first use. See “Descaling & Sanitizing” (page 49). To ensure proper operation, follow the installation checklist at the front of this manual.

NOTE: COSTS ASSOCIATED WITH ADJUSTMENTS, CLEANING AND SANITIZING PROCEDURES IN THIS GUIDE ARE NOT COVERED BY THE WARRANTY.

WARNING: DO NOT USE THE ICE MACHINE TO STORE ANYTHING OTHER THAN ICE.

WARNING: DO NOT OPERATE EQUIPMENT THAT HAS BEEN MISUSED, NEGLECTED, DAMAGED, ALTERED OR MODIFIED IN ANY WAY.

BREAKER RESET

The breaker switch is located behind the kickplate (see fig. 1). If the unit trips, press the breaker to reset the switch.

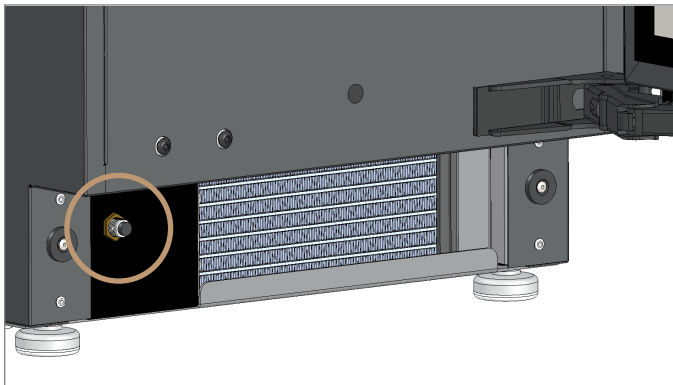



FIG. 1. Breaker switch location.

POWER SEQUENCE

- Press the power button  once to begin ice making operation. Press the button a second time to turn the ice machine off.
- When unit is plugged in, the control board goes through a sequence of checks to verify all sensors are working properly.
- The drain system is energized when power is supplied to the unit. It automatically turns on when it senses water in the drain tube.
- Display will show **oFF** until the power button is pressed.
- If the unit powers the drain pump but the drain remains clogged for five minutes, the display will show **drn** and cut power to the unit.
- If unit is too cold / too hot, or if the temperature probe is unplugged / failed, the unit shuts down and displays an error message.

ICE MAKING SEQUENCE

Your TRUE Ice® machine will produce one batch of ice (24 cubes) approximately every 20 minutes. The following steps occur during ice making–

INITIAL FILL / INITIAL HARVEST

The ice machine always begins in Fill mode. During Fill or Harvest modes–

- The display will read **FiL** (Fill mode) or **hAr** (Harvest mode).
- The reservoir fills with water (for 2–3 minutes)
- Excess / residual water drains.
- Any residual ice cubes from a previous cycle are melted free from the evaporator by warming the evaporator with a warm refrigerant (Harvest mode).

ICE MAKING

When making ice–

- The display will read **ICE**
- Water sprays into the inverted ice cups as the evaporator cools, forming ultra-clear ice cubes in each cup
- The compressor, condenser fan motor, and water pump operate.
- As ice is produced on the evaporator, the reservoir's water level will lower.
- Adjusting the ice cube size alters the water level needed for completing the cycle.
- The ice making cycle ends when
 - The reservoir's water level has dropped to a sufficient level based on the ice cube size setting OR
 - When the t1 evaporator probe detects the minimum temperature threshold.

ICE HARVEST

When harvesting ice–

- The display will read **hAr**
- The compressor remains on, but the condenser fan motor and pump turn off. The hot gas bypass and water valves open.
- As the evaporator warms, ice cubes begin to fall into the ice bin.
- The reservoir refills with water and overflows to flush impurities down to the drain pump.
- The harvest cycle ends when the evaporator reaches 47°F (8.3°C) and then a completion timer expires.
- All 24 ice cubes should fall into the ice storage bin before the next ice making cycle begins.

FULL BIN

When the ice bin is full–

- The display will read **FUL**
- The ice machine shuts off automatically when the ice level sensor determines the amount of ice has reached the set level (see "Adjust Ice Level", page 39).
- The condenser fan will turn on in reverse to clean the condenser; this removes any built-up dust or debris, which prolongs the time needed between full condenser coil cleanings.
- The drain pump will periodically run to remove any residual water in the bin from melted ice cubes.
- The ice machine turns back on when the ice level sensor determines the amount of ice has decreased to below the set level (see "Adjust Ice Level", page 39).

CABINET OPERATION

ELECTRONIC CONTROL OPERATION

ELECTRONIC CONTROL LEGEND



A. TOGGLES POWER/STANDY

B. TOGGLES BIN LIGHT COLORS/
SCROLL UP (IN MENU MODE)

C. DISPLAY

D. INITIATE AUTOMATIC CLEAN/
SCROLL DOWN (IN MENU MODE)

E. ADJUST CUBE SIZE

F. ADJUST BIN ICE LEVEL



WATER FILTER REMINDER



CLEANING REMINDER



AIR FILTER REMINDER

CABINET OPERATION

ELECTRONIC DISPLAY CODES

Display	Definition	Detailed Description
	Clean cycle reminder	In Menu Mode: view the number days elapsed since the automatic clean cycle was performed
	Drain pump failure	Clogged or kinked drain line. Drain was not able to clear within 5 minutes of running.
	Thermistor 1 Failure	Thermistor 1 is located on the evaporator outlet tube and is used for terminating the harvest. E1 means the probe has a bad or loose connection.
	Thermistor 2 Failure	Thermistor 2 is located on the condenser outlet tube and is used for fan cycling. E2 means the probe has a bad or loose connection.
	Fill mode	Water fills the reservoir for 2-3 minutes
	Condenser coil cleaning reminder	In Menu Mode: view the number of days elapsed since the last condenser coil cleaning.
	Freeze time	In Menu Mode: view the most recent freeze times in minutes. View history of five previous cycles: -1 (most recent), -2, -3, -4, -5
	Ice storage bin is full	Ice has reached the full level and the unit is in standby.
	Water level sensor	In Menu Mode: h1 is the water level reading inside the sump tank read in mm of H ₂ O.
	Ice level sensor	In Menu Mode: h2 is the ice level reading inside the ice storage bin in cm. Full = 35.0 and Empty = 55.0
	Harvesting ice	Ice cubes drop in the storage bin and water fills the reservoir for the next batch of ice.
	Harvest time	In Menu Mode: view the most recent harvest times in minutes. View history of five previous cycles -1 (most recent), -2, -3, -4, -5
	Making ice	Circulation pump is running, machine sprays water into the molds to make cubes.
	High Pressure sensor	In Menu Mode: P1 is the high side pressure transducer taken at the compressor discharge read in PSI (lb/in ²)
	Low Pressure sensor	In Menu Mode: P2 is the low side pressure transducer taken at the compressor suction read in PSI (lb/in ²)
	Water filter reminder	In Menu Mode: view the number of days elapsed since the last water filter replacement
	Evaporator temperature	In Menu Mode: t1 is the evaporator outlet temperature read in degrees Fahrenheit
	Condenser temperature	In Menu Mode: t2 is the condenser outlet temperature read in degrees Fahrenheit

DRAIN TIME ALARM

If the drain does not clear within 5 minutes of running, the display will show **drn** to signal a clogged / kinked drain line or a drain pump failure. The control automatically shut off the water supply.



If a clogged drain clears, the display will show **drn** and **oFF**.

CAUTION: ADHERE TO LOCAL AND STATE PLUMBING CODES. DO NOT EXCEED THE MAXIMUM PLUMBING HEIGHTS FOR THE GIVEN SETUP. SEE "DRAIN CONNECTION" (PAGE 23). THE DRAIN ALARM IS INITIATED BY THE CONTROL BOARD IN THE EVENT OF IMPROPER DRAINAGE.

NOTE: VERIFY THE ICE MAKER DRAINS THROUGH TWO CYCLES WITHOUT ANY ALARM DURING INSTALLATION.

MAINTENANCE REMINDERS

Your ice machine will remind you to clean, when to perform the automatic clean, when to clean condenser coil, and when to replace your water filter.

-  Water Filter reminder
-  Cleaning reminder
-  Air Filter reminder

CONDENSER CLEANING REMINDER

Days elapsed since last condenser coil cleaning.



WATER FILTER REMINDER

Days elapsed since last water filter replacement.



AUTOMATIC CLEANING REMINDER

Days elapsed since last performed automatic cleaning.



RESET REMINDERS

Press both **LIGHT** and **CLEAN**.

NOTE: RESETTING THE REMINDERS RESETS BOTH THE CONDENSER CLEANING AND THE WATER FILTER REPLACEMENT REMINDERS.

NOTE: THE AUTOMATIC CLEAN REMINDER CAN ONLY BE RESET BY COMPLETING THE AUTOMATIC CLEANING CYCLE.

BIN LIGHT



Press **LIGHT** to control the bin light.

- Press **LIGHT** repeatedly to cycle through the 14 preset designer light colors
- Press and hold **LIGHT** for 5 seconds to toggle the bin light on or off.

ADJUST CUBE SIZE

The ice cube size is easily adjustable to meet your usage.

The available cube sizes range from -6 (smallest) to +6 (largest). The default is 0. Please see fig. 1.

To adjust the cube size, press **SIZE** until the display shows the desired setting.

ADJUST ICE LEVEL

The ice bin level determines how much ice will be in the storage bin before the ice level sensor considers full (see fig. 1). The default setting is 100%. the level adjusts in 5% increments.

To adjust the ice level, press **LEVEL** until the display shows the desired setting.

ADJUST FOR WATER QUALITY

The water quality setting allows your ice machine to easily accommodate different levels of water quality / hardness / scale. The available settings range from 0 (soft water / low scale) to 5 (hard water / high scale). The default setting is 0. Please see fig. 1.

If you are unsure of your water quality, check your water with a water quality test kit (not provided by TRUE).

To adjust for water quality, press both **LIGHT** and **CLEAN**.

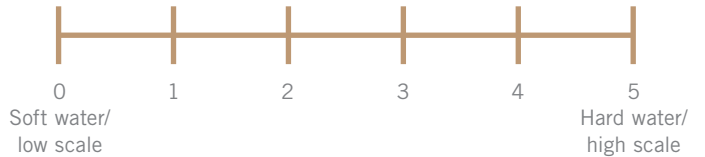























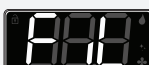







FIG. 1. Water quality setting range.

COMMANDS AND KEY COMBINATIONS

See the table below for commands and their corresponding key combinations (continued on next page).

Command	Key Combination	Display Code	Detailed Description
Power unit on / off	Press and hold POWER for 3 seconds  (3 sec)		Turns the unit on and off.
Adjust ice level	Press LEVEL until the display shows the desired setting 		Digitally adjust your "full" ice level lower in increments of 5%. The ice storage bin will be considered full at that value. Default 100%.
Change light color	Press LIGHT 		Switch between the 14 LED colors.
Adjust cube size	Press SIZE until the display shows the desired setting 		Adjusts cube size in increments from 1 to 6 for larger cubes, then -6 to -1 for smaller cubes. Ice Size default is 0.
Clean Mode	Press and hold CLEAN for 3 seconds  (3 sec)		Press and hold Clean for 3 seconds to begin (or end) the automatic cycle. Follow the prompts to select the settings and start the cycle.
Add cleaning chemicals	After adding cleaning chemicals, press CLEAN Add chemicals + 		In Clean Mode, the "Add" notification notifies when to add cleaners to the sump tank. Once complete, push any button to continue the automatic cycle.
Adjust for water quality	Press both LIGHT and SIZE  + 		Soft water / low scale setting is 0. Hard water / high scale setting is 5. Adjusting the value higher flushes more water between cycles, resulting in clearer ice cubes.

CABINET OPERATION

Command	Key Combination	Display Code	Detailed Description
Reset maintenance reminders	Press both LIGHT and CLEAN  + 		Resets the condenser cleaning and water filter replacement reminders. Both are reset when pressed. See "Maintenance Reminders" (page 38).
Circulate pump motor	Press clean twice Press CLEAN twice  X2		In Standby: Circulates the Pump motor (on / off).
Initiate manual drain pump operation	Press and hold both CLEAN and SIZE  + 	n/a	Bypasses the background operations and runs the drain pump only while buttons are held .
Initiate manual fill	Press clean 3 times Press CLEAN 3 times  X3		In Standby: Starts a Manual Fill Routine.
Initiate manual harvest	Press and hold both POWER and CLEAN for 3 seconds  +  (3 sec)		In Standby of Freeze: Starts a Manual Harvest Cycle.
Initiate reverse condenser cleaning	Press and hold POWER and SIZE for 3 seconds  +  (3 sec)		In Standby: Starts a Reverse Condenser Cleaning.
Clear the alarm history	Press POWER twice  X2	n/a	Removes any alarms from the machine's memory.

GENERAL MAINTENANCE

WATER FILTER REPLACEMENT

CONDENSER COIL CLEANING

STAINLESS STEEL EQUIPMENT CARE AND CLEANING

DESCALING & SANITIZING

INTERIOR COMPONENTS

WINTERIZING



PRESERVE THE MOMENT®

GENERAL MAINTENANCE

You are responsible for maintaining the ice machine in accordance with the instructions in this manual. Maintenance procedures are not covered by warranty.

True recommends performing the following maintenance procedures a minimum of once every six months to ensure reliable, trouble-free operation.

WARNING: IF YOU DO NOT UNDERSTAND THE NECESSARY PROCEDURES OR SAFETY PRECAUTIONS, CALL YOUR LOCAL TRUE SERVICE REPRESENTATIVE TO PERFORM MAINTENANCE PROCEDURES FOR YOU.

CAUTION: TAKE CARE DURING OPERATION, MAINTENANCE, OR REPAIRS TO AVOID CUTS OR PINCHING FROM ANY CABINET PART/ COMPONENT

EXTERIOR CLEANING

Clean the exterior as needed. Follow stainless steel cleaning recommendations (page 47) to ensure your machine always looks like new.

DESCALING & SANITIZING

Descale and sanitize every 6 months. See "Descaling & Sanitizing" (page 49).

WATER FILTER REPLACEMENT

Replace the water filter at least once every 12 months. More frequent replacement may be required based on your water quality. See "Water Filter Replacement" (page 45).

CONDENSER CLEANING

For optimum operation, clean your condenser coil every 6 months. See "Condenser Coil Cleaning" (page 46).

MAINTENANCE	WEEKLY	SEMI-ANNUAL	ANNUAL	AFTER PROLONGED SHUTDOWN	AT START-UP
CLEAN CABINET EXTERIOR	X			X	X
SANITIZE ICE MACHINE		X	X	X	X
DESCALE ICE MACHINE		X	X	X	X
CLEAN CONDENSER COIL		X	X	X	
CHANGE THE WATER FILTER		X	X	X	
CHECK ICE QUALITY	X	X	X	X	X

WATER FILTER REPLACEMENT

To order a replacement water filter, go to <https://store.trueresidential.com/collections/maintenance-1>

or contact our parts department at **844-849-6226** or TrueResidentialParts@TrueMfg.com.

NOTE: BE SURE TO RESET THE WATER FILTER REPLACEMENT REMINDER AFTER REPLACING THE WATER FILTER. SEE "MAINTENANCE REMINDERS" (PAGE 38).



CAUTION: DO NOT install the water filter while the water supply is pressurized. **Always** relieve the water pressure before changing the filter.

1. Relieve the water pressure.
2. Rotate the water filter counterclockwise and pull the filter from the unit. See fig. 1.
3. Insert the replacement water filter and rotate the filter clockwise. See fig. 2.



FIG. 1. Rotate the existing water filter counterclockwise.

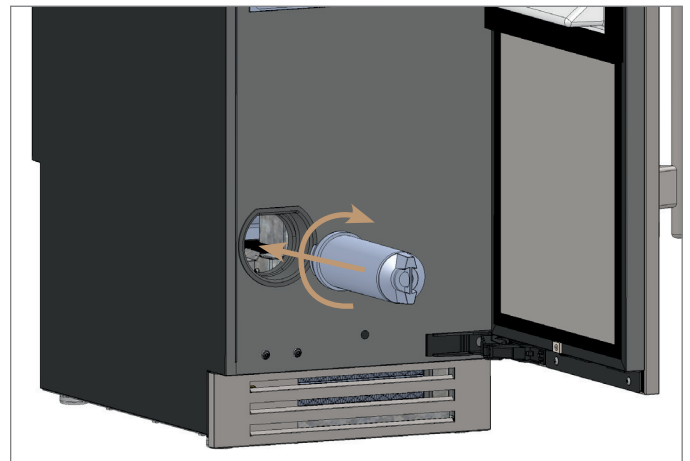

FIG. 2. Insert the replacement water filter and rotate it clockwise.

CONDENSER COIL CLEANING

Keeping the condenser coil clean minimizes required servicing and lowers electrical cost. Warranty does not cover cleaning the condenser coil.

NOTE: BE SURE TO RESET THE CONDENSER COIL CLEANING REMINDER AFTER CLEANING THE CONDENSER COIL. SEE "MAINTENANCE REMINDERS" (PAGE 38).



WARNING – Electrical shock or burn hazard. Unplug the unit or turn off the power supply before proceeding. **DO NOT** clean appliance with a pressure washer or hose.



CAUTION – Risk of eye injury from debris. Eye protection is recommended.



CAUTION – Coil fins are sharp. Gloves are recommended.

REQUIRED TOOLS

Required tools include (but may not be limited to) the following.

- Gloves
- Vacuum Cleaner
- Eye Protection
- Flashlight
- Stiff Bristle Brush
- Tank of Compressed Air

CLEANING STEPS

1. Remove the kickplate. See fig. 1.
2. With a stiff bristle brush, carefully clean accumulated dirt from the front coil fins.
3. With the dirt removed from the surface of the coil, use a flashlight to verify you can see through the coil and observe the condenser fan blade spinning. See fig. 3.
4. If the view is clear, reinstall the kickplate, restore power, and verify correct operation.

5. If the view is not clear, gently blow compressed air or CO₂ through the coil until it is clean.
6. Carefully vacuum any dirt around the condensing unit area.
7. Reinstall the kickplate, restore power, and verify correct operation.

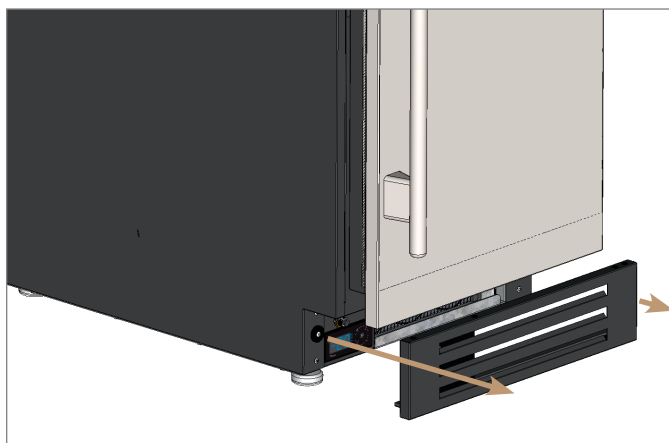

FIG. 1. Pull the kickplate off the magnets.

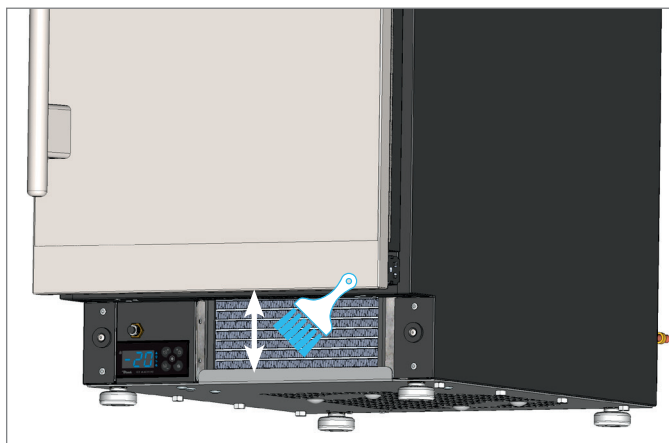

FIG. 2. Never brush across the coil fins.

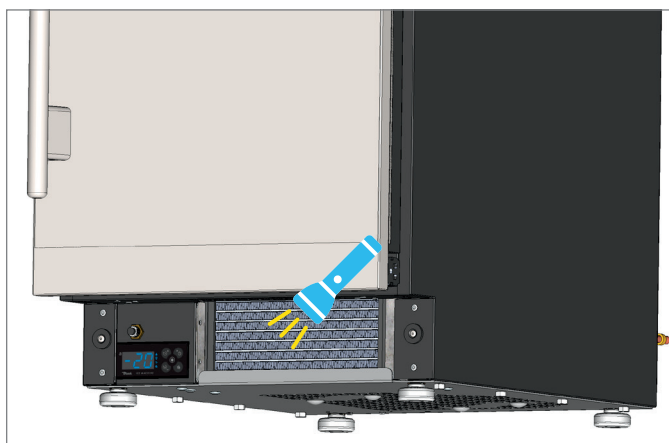

FIG. 3. Verify all blockages have been removed.

STAINLESS STEEL EQUIPMENT CARE AND CLEANING



CAUTION: DO NOT USE ANY STEEL WOOL, ABRASIVE OR CHLORINE BASED PRODUCTS TO CLEAN STAINLESS STEEL SURFACES.

STAINLESS STEEL OPPONENTS

There are three basic things which can break down your stainless steel's passivity layer and allow corrosion to rear its ugly head.

- Scratches from wire brushes, scrapers, and steel pads are just a few examples of items that can be abrasive to stainless steel's surface.
- Deposits left on your stainless steel can leave spots. You may have hard or soft water depending on what part of the country you live in. Hard water can leave spots. Hard water that is heated can leave deposits if left to sit too long. These deposits can cause the passive layer to break down and rust your stainless steel. All deposits left from food prep or service should be removed as soon as possible.
- Chlorides are present in table salt, food, and water. Household and industrial cleaners are the worst type of chlorides to use.

STAINLESS STEEL CLEANING AND RESTORATION

Do not use stainless steel cleaners or similar solvents to clean plastic or powder-coated parts. Instead, use warm soapy water.

- For routine cleaning and removal of grease and oil, apply white vinegar, ammonia, or any good commercial detergent* with a soft cloth or sponge.
- Stainless steel polish (i.e., Zep® Stainless Steel Polish, Weiman® Stainless Steel Cleaner & Polish, Nyco® Stainless Steel Cleaner & Polish, or Ecolab® Ecoshine®) and olive oil can act as a barrier against fingerprints and smears.
- Degreasers* (i.e., Easy-Off® Specialty Kitchen Degreaser or Simple Green® Industrial Cleaner & Degreaser) are excellent for removal of grease, fatty acids, blood and burnt-on foods on all surfaces.
- For restoration/passivation or removing stubborn stains and discoloration, Brillo® Cameo®, Zud® Cleanser, Ecolab® Specifax™ First Impression® Metal Polish, Sheila Shine, or talc can be applied by rubbing in the direction of the polish lines.

*Do not use detergents or degreasers with chlorides or phosphates.

NOTE: THE USE OF PROPRIETARY NAMES IS INTENDED FOR EXAMPLE ONLY AND DOES NOT CONSTITUTE OR IMPLY AN ENDORSEMENT. OMISSION OF PROPRIETARY CLEANSERS FROM THIS LIST DOES NOT IMPLY INADEQUACY.

8 TIPS TO HELP PREVENT RUST ON STAINLESS STEEL

- **Maintain the Cleanliness of Your Equipment** – Avoid build-up of hard stains by cleaning frequently. Use cleaners at the recommended strength (alkaline chlorinated or non-chloride).
- **Use the Correct Cleaning Tools** – Use non-abrasive tools when cleaning your stainless steel products. The stainless steel's passive layer will not be harmed by soft cloths and plastic scouring pads.
- **Clean Along Polishing Lines** – Polishing lines ("grain") are visible on some stainless steels. Always scrub parallel to polishing lines when visible. Use a plastic scouring pad or soft cloth when you cannot see the grain.
- **Use Alkaline, Alkaline-Chlorinated or Non-Chloride Cleaners** – While many traditional cleaners are loaded with chlorides, the industry is providing an ever increasing choice of non-chloride cleaners. If you are not sure of your cleaner's chloride content, contact your cleaner supplier. If they tell you that your present cleaner contains chlorides, ask if they have an alternative. Avoid cleaners containing quaternary salts, as they can attack stainless steel, causing pitting and rusting.
- **Rinse** – When using chlorinated cleaners, you must rinse and wipe dry immediately. It is better to wipe standing cleaning agents and water as soon as possible. Allow the stainless steel equipment to air dry. Oxygen helps maintain the passivity film on stainless steel.
- **Never Use Hydrochloric Acid (Muriatic Acid) on Stainless Steel** – Even diluted, hydrochloric acid can cause corrosion, pitting and stress corrosion cracking of stainless steel.
- **Water Treatment** – To reduce deposits, soften hard water when possible. Installation of certain filters can remove corrosive and distasteful elements. Salts in a properly maintained water softener can also be to your advantage. Contact a treatment specialist if you are not sure of the proper water treatment.
- **Regularly Restore & Passivate Stainless Steel** – Stainless steel gets its stainless properties from the protective chromium oxides on its surface. If these oxides are removed by scouring, or by reaction with harmful chemicals, then the iron in the steel is exposed and can begin to oxidize, or rust. Passivation is a chemical process that removes free iron and other contaminants from the surface of stainless steel, allowing the protective chromium oxides to re-form.

DESCALING & SANITIZING

You should fully descale your ice machine every 6 months. Descaling also involves removing key ice machine parts and rinsing them and the inside of the machine with ice machine descaler.

Sanitizing the ice machine removes potential biological contaminations and molding. The sanitation process is identical to the descaling process, except that a sanitizing agent is used in place of the descaling chemicals.

WARNING: WEAR RUBBER GLOVES AND EYE PROTECTION WHEN HANDLING ICE MACHINE DESCALER OR SANITIZER.

CAUTION: DO NOT COMBINE DESCALER AND SANITIZER.

DESCALING

1. Press and hold **CLEAN** for 3 seconds. The display will show **dES**.
2. Press **LIGHT** and / or **CLEAN** until the display shows either **dES** (descal only) or **bth** (both descale and sanitize).



Run descale cycle only



Run both descale and sanitize cycles

3. With the display showing the desired cycle, press the TRUE logo. The display will show **Str**.



4. Press **LIGHT** and / or **CLEAN** until the display shows either **Str** or **Stb** (standby). This determines the ice machine's action upon completion of the selected cleaning cycle.



Machine will begin ice making sequence



Machine will enter standby

5. With the display showing the desired action, press the TRUE logo. The selected cleaning cycle will begin.
6. The display will alternate between **PrE** and **CLn** (preclean) for approximately 3 minutes.



Preclean stage

7. When the display shows Add, pour 6 fl. oz. of undiluted True Ice™ Machine Descaler into the spray compartment behind the water shutters.



Add cleaning chemicals

8. After adding the descaler, press the TRUE logo. The automatic cycle will continue.



While running the automatic clean cycle

9. Wait for the rinse and drain cycles to complete (30 minutes). For light descaling, proceed to step 14.
10. Remove the ice guide, water shutters, spray bar and pump clean-out cap. See "Interior Components" (page 51).
11. Mix a descaling solution of 10 fl. oz. undiluted True Ice™ Machine Descaler and 1 gal. of water.
12. With approximately half the descaling solution, clean the removed parts with a brush; then soak them for 20 minutes.
13. With the remaining solution, descale the ice bin, door, door gasket, spray compartment, and evaporator.
14. Rinse all parts with clean water.

SANITIZING

1. Remove the ice guide, water supply, spray bar and pump clean-out cap. See "Interior Components" (page 51).
2. Mix 1.5 fluid ounces (3 tbsp) of 5.25% hypochlorite solution (chlorine bleach) with 3 gallons of warm water.
3. Use 1/2 of the solution to sanitize the removed parts. Soak the parts in the solution. **DO NOT RINSE THE PARTS AFTER SANITIZING.**
4. With the remaining solution, sanitize the interior surfaces of the machine and the bin. **DO NOT RINSE THE SANITIZED AREAS.**
5. Reinstall the components.
6. Press and hold **CLEAN** for 3 seconds. The display will show **dES**.
7. Press **LIGHT** and / or **CLEAN** until the display shows either **SAn** (descale only) or **bth** (both descale and sanitize).



Run Sanitize cycle only



Run both descale and sanitize cycles

8. With the display showing the desired cycle, press the TRUE logo. The display will show **Str**.



9. Press **LIGHT** and / or **CLEAN** until the display shows either **Str** (startup) or **Stb** (standby). This determines the ice machine's action upon completion of the selected cleaning cycle.



Machine will begin ice making sequence



Machine will enter standby

10. With the display showing the desired action, press the TRUE logo. The selected cleaning cycle will begin.

11. The display will alternate between **PrE** and **CLn** (preclean) for approximately 3 minutes.



Preclean stage

12. When the display shows **Add**, pour 2 teaspoons of 5.25% hypochlorite solution (chlorine bleach) into the spray compartment behind the water shutters.



Add cleaning chemicals

13. After adding the sanitizer solution, press the TRUE logo. The automatic cycle will continue.



While running the automatic clean cycle

14. Wait for the sanitizing cycle to finish. Immediately rinse off and dry any exterior areas where sanitizing solution may have spilled.

INTERIOR COMPONENTS

See the following for the removal and correct installation of the interior components.

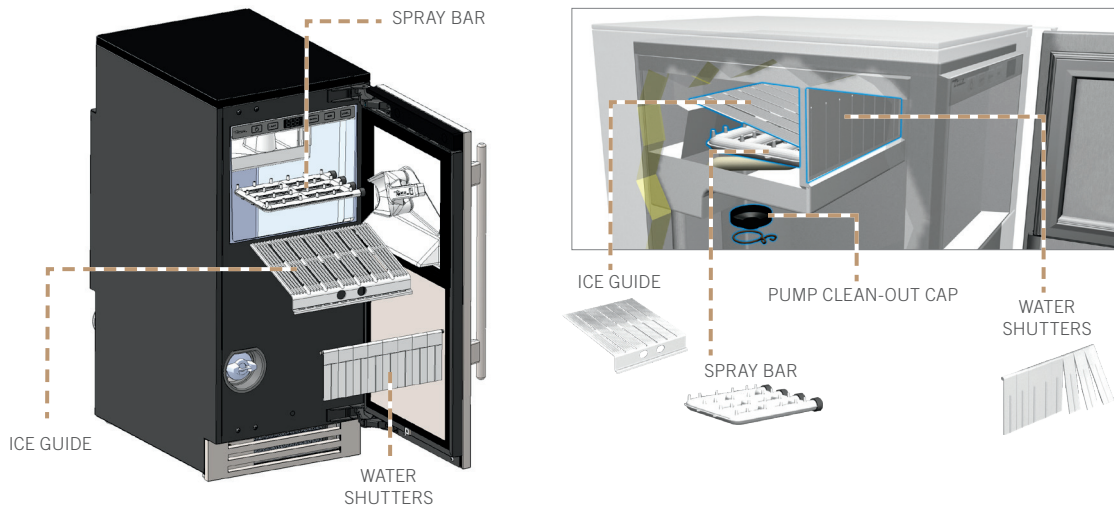

WATER SHUTTER

The water shutter hangs in front of the spray bar and ice guide. It prevents spraying water from escaping the evaporator compartment.

REMOVAL

Lift the shutter rod's ends from the recesses in the sidewall.

INSTALLATION

Insert the shutter rod's ends into the recesses in the sidewall. To be correctly installed, the water shutter must–

- Hang from a shutter rod fully seated in the recessed end supports.
- Conceal the ice guide finger holes.

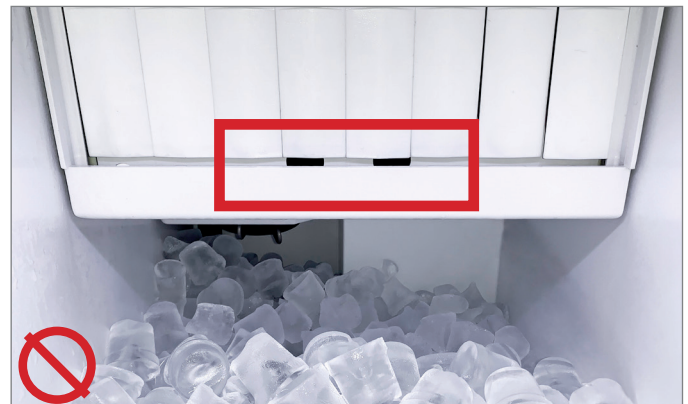

INCORRECT. Ice guide finger holes are visible.



CORRECT. Ice guide finger holes are hidden; ice guide slotted holes are visible.

ICE GUIDE

The ice guide sits over the spray nozzles and directs falling ice into the bin.

REMOVAL

Lift the front of the guide and pull the guide forward.

INSTALLATION

Position the ice guide over the spray bar. To be correctly installed, the ice guide must–

- Be firmly positioned over the spray bar.
- Sit with its front edge inside the water trough.
- Have its slots aligned with the spray nozzles.



INCORRECT. Ice guide positioned too far inside the water trough.



INCORRECT. Ice guide positioned outside the water trough.



CORRECT. Ice guide positioned in the guide channel and flush against the back side of the water trough opening.

SPRAY BAR

REMOVAL

Carefully pull the spray bar from the water supply hose.

INSTALLATION

The spray bar, located in the water trough, supplies water to the individual ice cube cups. To be correctly installed, the spray bar must—

- Be positioned with the clean-out caps on the right.
- Sit fully seated and horizontally level.

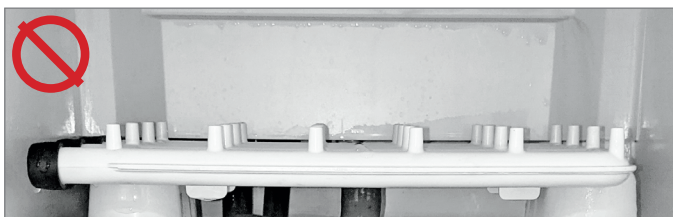

INCORRECT. Spray bar positioned with clean-out caps on the left.



INCORRECT. Spray bar is not fully seated or level.



CORRECT. Spray bar is fully seated, level, and positioned with the clean-out caps on the right..

PUMP CLEAN-OUT CAP

REMOVAL

1. Remove the pump clamp. See fig. 1.
2. Pull the clean-out cap down.

INSTALLATION

1. Slide the clean-out cap over the hole beneath the pump.
2. Reinstall the pump cap clamp.

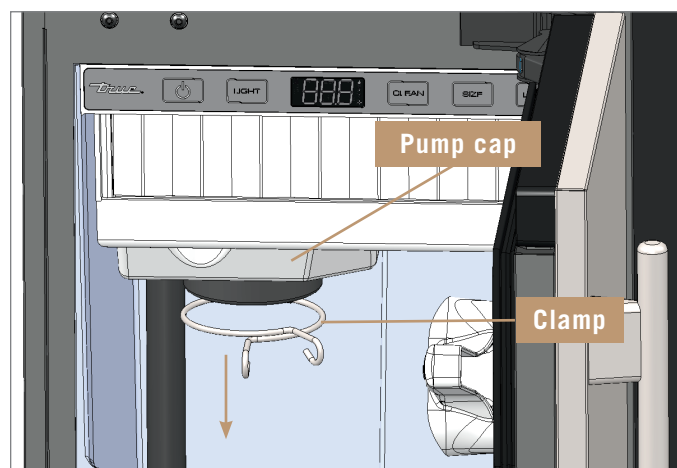

FIG. 1. Pump cap and clamp locations.

WINTERIZING

CAUTION: DO NOT ALLOW THE ICE MACHINE TO BE EXPOSED TO TEMPERATURES BELOW 32°F (0°C) WITHOUT WINTERIZING THE UNIT AS THIS WILL CAUSE ANY WATER IN THE MACHINE TO FREEZE. FAILURES CAUSED BY EXPOSURE TO FREEZING TEMPERATURES ARE NOT COVERED BY THE WARRANTY.

Use the following instructions to prepare your ice machine for storage or winterization:

1. Descale and sanitize the ice machine. See "Descaling & Sanitizing" (page 49).
2. Turn off the water supply to the machine.
3. Disconnect the incoming water line from the back of the unit.
4. Remove and discard the water filter. See "Water Filter Replacement" step 1 (page 45).
5. Drain the evaporator compartment by removing the pump clean-out cap. See "Pump Clean-out Cap" (page 53).
6. Pour 1 gallon of propylene glycol (RV antifreeze) into the bin drain to fill the drain pump.
7. Once the drain pump shuts off and all the propylene glycol is drained, unplug the unit or turn off the circuit breaker.
8. Wipe down the interior bin with a dry clean cloth.
9. Re-install the pump clean-out cap.

RESTARTING

Use the following instructions to restart your ice machine after winterization:

1. Install a new water filter in the unit. See "Water Filter Installation" (page 30).
2. Reconnect the incoming water line and turn on the water supply.
3. Plug in the unit.
4. Descale the ice machine. See "Descaling" (page 49).
5. Press power  to start ice making.

NOTE: THE FRESH WATER THAT IS INTRODUCED DURING DESCALING AND START-UP WILL FLUSH THE PROPYLENE GLYCOL DOWN THE DRAIN.

SERVICING, REPLACING COMPONENTS & ADJUSTMENTS

REVERSING DOOR

DOOR ADJUSTMENT

CONTACT US



PRESERVE THE MOMENT®

SERVICING & REPLACING COMPONENTS

NOTE: ANY CABINET ADJUSTMENTS ARE TO BE MADE AFTER THE CABINET HAS BEEN VERIFIED LEVEL AND PROPERLY SUPPORTED.

- Replace component parts with original equipment manufacturer (OEM) components.
- Contact the dealer or our parts department at **844-849-6179** or **TrueResidentialParts@truemfg.com** for replacement parts.
- Have a licensed service provider service your unit to minimize the risk of possible ignition due to incorrect parts or improper service and to ensure the operator's health and safety.
- Unplug the ice machine before cleaning or making any repairs. Powering off an electronic control may not remove power from all components (e.g., light circuits, perimeter heaters, and evaporator fans).

REVERSING DOOR

The new TUI-15 models come with articulating, soft-close hinges. The hinges can be installed on either the left-hand or right-hand orientation.

To order additional spacers of NSF cover screw caps, contact our parts department at **844-89-6226** or **TrueResidentialParts@TrueMfg.com**.

REQUIRED TOOLS

Required tools include (but may not be limited to) the following:

- 1/8" Hex Head Allen Wrench
- Putty Knife (if NSF cover present)

PROCEDURE

NOTE: Figures show converting a right-hinged door to a left-hinged door.

1. Loosen the hinge bolts and remove the door. See fig. 1.
 2. If NSF Cover is present, carefully pry screw caps from the cover to access the door bracket screws. See fig. 2.
 3. If present, remove the door skin. See fig. 3.
 4. Remove the existing spacer. See fig. 3.
 5. Remove the hinge assemblies from the door assembly. See fig. 4.
 6. Shift the door brackets to the opposite side. See fig. 5.
 7. Install the bottom hinge at the top and the top hinge on the bottom. See figs. 6 and 7.
 8. Install the door skin. If present, reinstall the NSF cover screw caps.
 9. Move the remaining door hardware to the opposite sides. See fig. 8.
 10. Install the reversed door. Be sure to fully tighten the hinge screws.
- NOTE: BE SURE TO INSTALL THE CORRECT SPACER FOR YOUR DOOR ORIENTATION.**
11. Verify the door closes correctly and the gasket seals without gaps. Adjust the door as needed. See "Door Adjustment" (page 59).

SERVICING, REPLACING COMPONENTS & ADJUSTMENTS



FIG. 1. Slide the door off the hinge bolts through the keyhole slots.

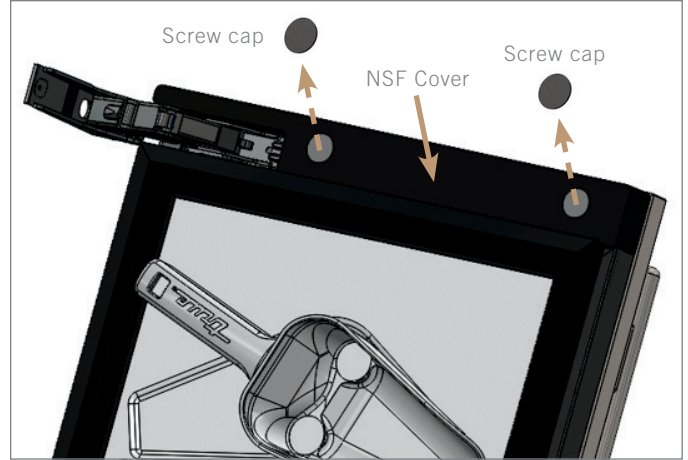

FIG. 2. Remove the NSF cover screw caps.

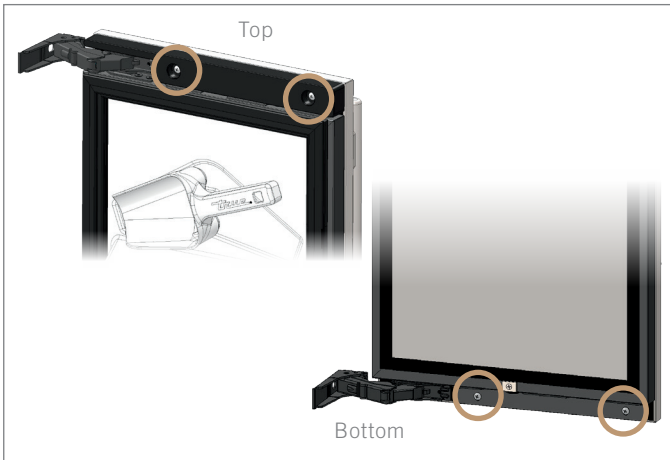

FIG. 3. Spacer and door bracket screw locations.

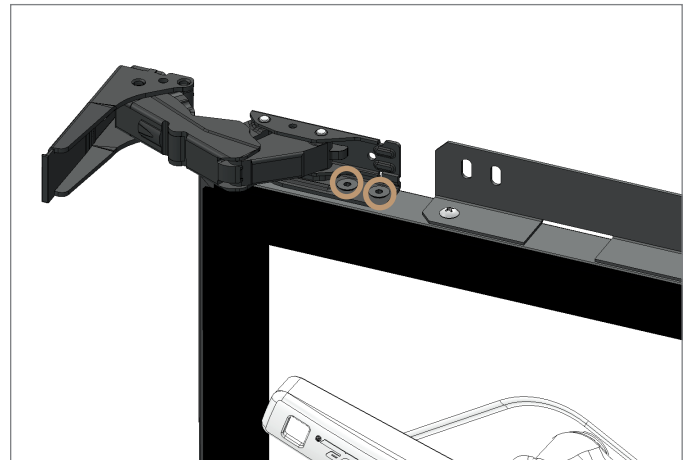

FIG. 4. Hinge door screw locations. Top hinge shown.

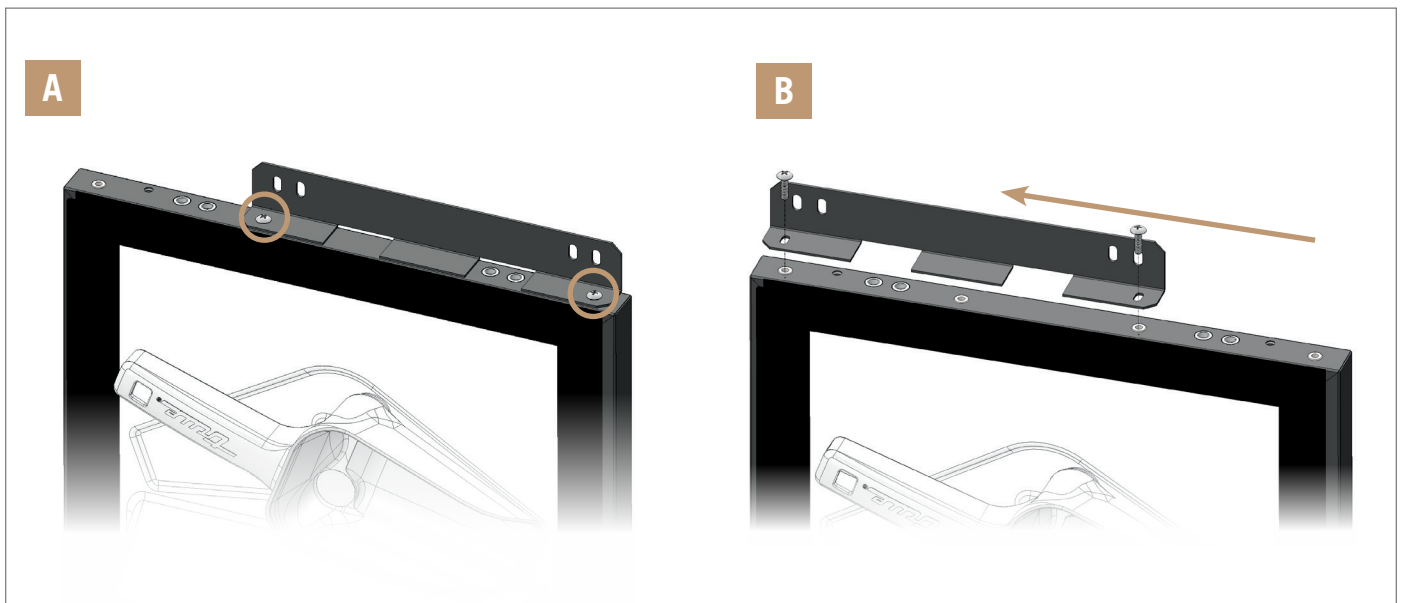

FIG. 5. Top Bracket shown.
 A: Door Skin bracket screw locations.
 B: Move the door skin bracket to the opposite side.

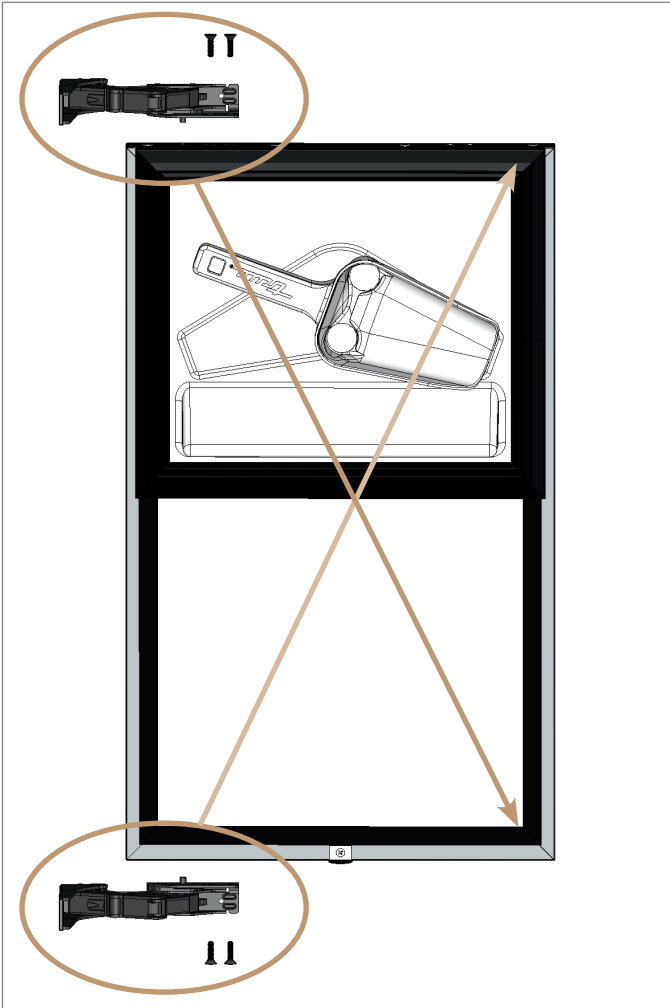

FIG. 6. Switch the top and bottom hinge assemblies with each other.

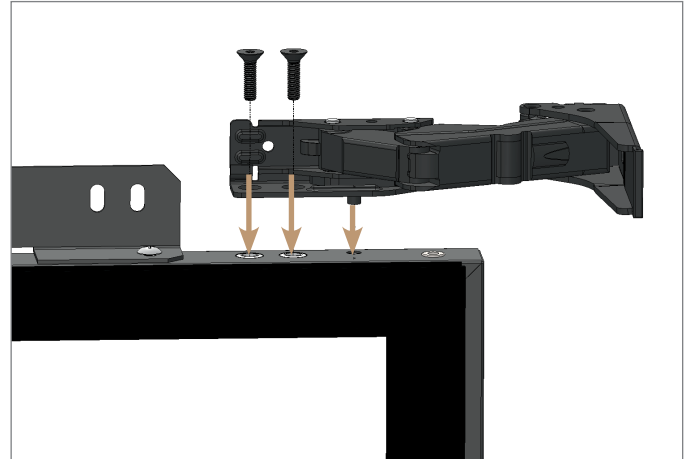

FIG. 7. Install the hinge assembly.

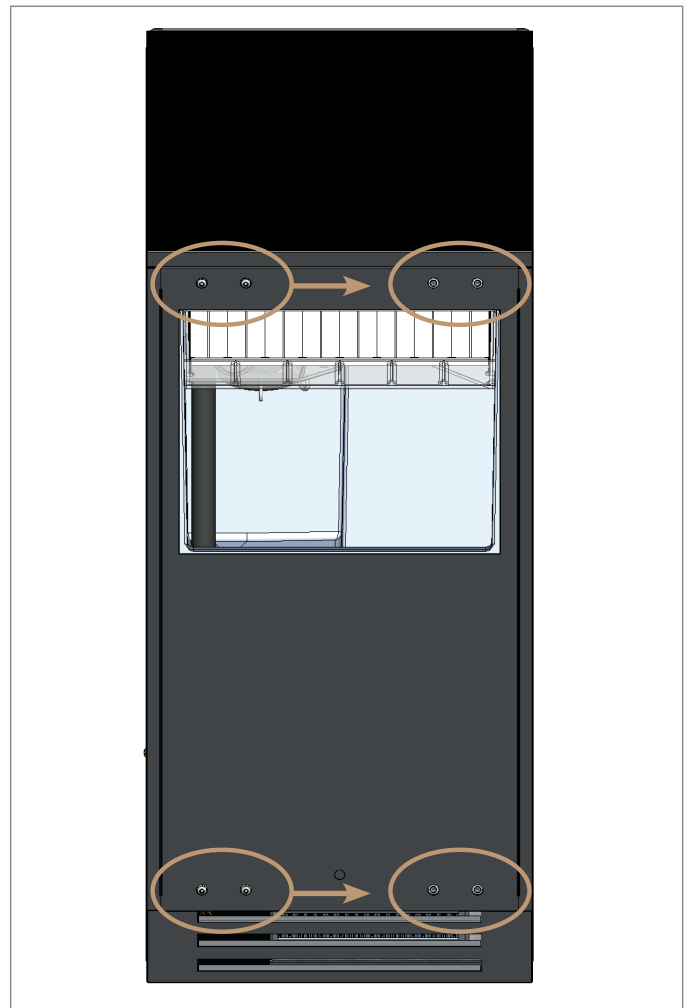

FIG. 8. Move the remaining door hardware to the opposite side.

DOOR ADJUSTMENT

Door skin bracket screw holes are slotted to assist with door adjustment. See figs. 1–3

1. If applicable, remove the NSF cover screw caps.
2. Loosen the door skin bracket and spacer screws. See figs. 1–3
3. Adjust the door skin / panel as needed.
4. Tighten the door skin bracket and spacer screws.
5. If applicable, reinstall NSF cover screw caps.

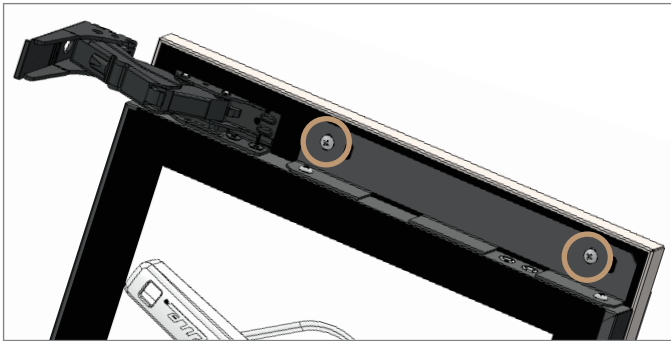

FIG. 1. Spacer / top door bracket screw locations.



FIG. 2. Bottom door bracket screw locations.



FIG. 3. Bracket screw holes are slotted for easy adjustment. Screw removed for illustration.

CONTACT US

For any questions about installation, please contact your TRUE dealer or TRUE Residential Technical Service. Please have your model and serial number (see serial label location below) available so we can better assist you with your service- or parts-related inquires.

Customer Service

Phone: 888-616-8783
info@true-residential.com

Warranty Department

Phone: 844-849-6179
TrueResidentialWarranty@truemfg.com

Service Department

Phone: 844-746-9423
TrueResidentialService@truemfg.com



TRUE RESIDENTIAL® LIMITED ICE MACHINE WARRANTY

LIMITED 30-DAY COSMETIC WARRANTY

Stainless steel doors and handles are warranted to be free from defective materials and workmanship for a period of thirty (30) days from the date of original retail purchase. Any defects must be reported to the selling dealer within thirty (30) days from the date of original retail purchase. This limited warranty excludes any type of freight / concealed damage.

THREE-YEAR PARTS & LABOR WARRANTY

TRUE warrants to the original purchaser of every new True Ice™ machine, the cabinet and all parts thereof, to be free from defects in material and workmanship under normal and proper use and maintenance as specified by TRUE and upon proper installation and start-up in accordance with the instruction packet supplied with each TRUE unit. TRUE's obligation under this warranty is limited to a period of three (3) years from the date of original installation or thirty-nine (39) months after shipment date from TRUE, whichever occurs first.

Contact the factory regarding warranty for installations in a commercial/light commercial application.

SIX-YEAR SEALED SYSTEM WARRANTY - PARTS & LABOR

TRUE warrants its hermetically sealed system: compressor, evaporator coil, condenser coil, drier, metering device and connecting tubing to be free from defects in both material and workmanship under normal and proper use and maintenance service for a period of six (6) years from the date of original installation but not to exceed six (6) years and three (3) months after shipment from the manufacturer, whichever occurs first.

DISPLAY PRODUCTS

True Residential Products on showroom display that are sold more than 3 years (36 months) from the invoice date to the dealer would carry a 1 year parts and labor warranty, along with an additional 4 year sealed system, parts only warranty.

TERMS APPLICABLE TO EACH WARRANTY

Any part covered under the above warranties that is determined by TRUE to have been defective within the time frame is limited to the repair or replacement, including labor charges, of defective parts or assemblies. The labor warranty shall include standard straight time labor charges only and reasonable travel time, as determined by TRUE.

WARRANTY CLAIMS

All claims for labor or parts must be made directly through TRUE. All claims should include: model number and serial number of ice machine, proof of purchase, and date of installation. In case of warranted compressor, the compressor model tag, or picture of tag must be returned to TRUE along with the above listed information. Warranty labor claim is subject to denial if failed part is requested for return and it is not returned.

WHAT IS NOT COVERED BY THIS WARRANTY

TRUE's sole obligation under this warranty is limited to either repair or replacement of parts, subject to the additional limitations below.

This warranty neither assumes nor authorizes any person to assume obligations other than those expressly covered by this warranty. This warranty does not cover failures related to the water supply, problems in the plumbing going to the unit, or external drain line malfunctions. Also not covered are failures resulting from ambient conditions that are outside the limits specified in the owners manual.

NO CONSEQUENTIAL DAMAGES

TRUE is not responsible for economic loss, profit loss or special, indirect or consequential damages, including without limitation, losses or damages arising from ice loss or ice replacement costs, normal maintenance, after-install adjustments or cleaning or water damage claims whether or not on account of refrigeration failure.

WARRANTY IS NOT TRANSFERABLE

This warranty is not assignable and applies only in favor of the original purchaser / user to whom delivered. Any such assignment or transfer shall void the warranties herein made and shall void all warranties, express or implied, including any warranty or merchantability or fitness for a particular purpose.

IMPROPER USAGE

TRUE assumes no liability for parts or labor coverage for component failure or other damages resulting from improper usage or installation or failure to clean and / or maintain product as set forth in the users manual provided with the unit.

ALTERATION OR NEGLECT

TRUE is not responsible for the repair or replacement of any parts that TRUE determines have been subjected, after the date of manufacture, to alteration, neglect, abuse, misuse, accident, damage during transit or installation, fire, flood, or act of God.

IMPROPER ELECTRICAL CONNECTIONS

TRUE is not responsible for the repair or replacement of failed or damaged components resulting from electrical power failure, high or low voltage, use of extension cords, or improper grounding of the unit.

YOUR RIGHTS UNDER STATE LAW

Some states do not allow the exclusion or limitation of consequential damages or a limitation on how long an implied warranty lasts, so these exclusions or limitations may not apply to you.

This warranty gives you specific legal rights and you may have other rights that vary from state to state.

ENVIRONMENTAL ATTRIBUTES

Any and all environmental attributes, including environmental offset credit rights, with respect to TRUE® refrigeration units manufactured after September 1, 2015, shall remain the property of True Manufacturing Co., Inc. and are not transferred.

OUTSIDE U.S. / CANADA

This warranty does not apply to, and TRUE is not responsible for, any warranty claims made on products sold or used outside the United States or Canada.

SUBMIT WARRANTY CLAIMS TO:

True Residential
Attn: Warranty Dept
2001 East Terra Lane
O'Fallon, MO 63366
Or
TrueResidentialWarranty@truemfg.com

CONTACT US

true-residential.com

636.240.2400 | toll free 888.616.8783



PRESERVE THE MOMENT®