



TRUE RESIDENTIAL®

15 INCH AND 24 INCH UNDERCOUNTER SERVICE MANUAL

“A” AND “B” REVISIONS

True®

PRESERVE THE MOMENT®

THANK YOU

FOR YOUR PURCHASE

TABLE OF CONTENTS

INTRODUCTION 1

INSTALLATION CHECKLIST	2
SAFETY PRECAUTIONS / DATA TAG INFORMATION	3
DEPARTMENT CONTACT INFORMATION	4
ELECTRICAL SPECIFICATIONS	5
DUAL ZONE HOME ALARM SYSTEM	6
UNCRATING	7
LEVELING REFRIGERATOR	8
INSTALLATION ANTI-TIP BRACKETS	9-10
INSTALLING THE DOOR STOP	11
INSTALLING 90° DOOR HINGE (OPTION)	11-13
DRAWER DEPTH ADJUSTMENTS	14
DRAWER FRONTS ADJUSTMENTS	15
DRAWER GLIDES ADJUSTMENTS	15
DOOR REMOVAL	16
STAINLESS STEEL & STAINLESS GLASS DOOR ADJUSTMENTS	17
OVERLAY PANEL AND OVERLAY PANEL GLASS / GLASS DOOR ADJUSTMENTS	18
WINE SHELVING ADJUSTMENTS / GLASS SHELVING ADJUSTMENT	19
LED LIGHTING	20
STACKING KIT	21-22

TECHNICAL DATA 23

SOFTWARE INFORMATION AND START UP MODE	24
SEQUENCE OF OPERATION	25
USER INTERFACE COMMANDS	26-27
DEFROST	28
EVAPORATOR COVER REMOVAL	29-30
EVAPORATOR SECTION LAYOUT	31-32
PROBES VALUES	32
EVAPORATOR FAN DRIVER	32
CONTROL BOARD REPLACEMENT AND MODEL SELECT SEQUENCE OF OPERATION	33
WIRING DIAGRAMS	34-44

COMPRESSOR OPERATION 45

TYPES OF COMPRESSORS AND SPECIFICATIONS	46
VARIABLE SPEED COMPRESSOR DIAGNOSTICS	47
INVERTER BOARD DIAGNOSTICS TABLE	48
COMPRESSOR COMPARTMENT LAYOUT	49

SEALED SYSTEM 50

GOOD REFRIGERATION PRACTICES	51
SYSTEM PRESSURES	51
TROUBLESHOOTING, REPAIRS AND REPLACEMENT	52-54

MAINTENANCE 55

STAINLESS STEEL CARE AND CLEANING	56
GASKET CLEANING	57
GENERAL MAINTENANCE	57
WARRANTY	58

INTRODUCTION

INSTALLATION CHECKLIST

SAFETY PRECAUTIONS

DATA TAG INFORMATION

DEPARTMENT CONTACT INFORMATION

ELECTRICAL SPECIFICATIONS

DUAL ZONE HOME ALARM SYSTEM

UNCRATING

LEVELING REFRIGERATOR

INSTALLATING ANTI-TIP BRACKETS

INSTALLATING THE DOOR STOP

INSTALLING 90° DOOR HINGE (OPTION)

DRAWER DEPTH ADJUSTMENTS

DRAWER FRONTS ADJUSTMENTS

DRAWER GLIDES ADJUSTMENTS

DOOR REMOVAL

STAINLESS STEEL & STAINLESS GLASS DOOR ADJUSTMENTS

OVERLAY PANEL & OVERLAY PANEL GLASS DOOR ADJUSTMENTS

WINE SHELVING ADJUSTMENTS/GLASS SHELVING ADJUSTMENT

LED LIGHTING

STACKING KIT



INSTALLATION CHECKLIST

To ensure a proper installation, this checklist should be completed to ensure that no part of the process has been overlooked.

- Has the electrical circuit been verified of using a dedicated 15-amp circuit with the ground plug attached and correct polarity. Discrepancies in the supplied power can cause serious damage and potentially void all warranty. Please see page (5) for a more detailed description of electrical guidelines.
- Have all the packaging materials been removed? NOTE: please make sure the toe kick which is taped to the back of the unit is removed prior to pushing the unit in place.
- Have the anti-tip brackets been installed securely and are they properly engaging the unit? NOTE: the location of the anti-tip brackets is taped within the toe kick packaging. For installation instructions please see page (9).
- Is the unit leveled properly with all leveling legs making contact with the floor? Has the toe kick been installed? Proper leveling should be done from the inside of the unit rather than the top exterior of the unit.
- Has the door stop been installed?
- Has the customer been given the installation / user guide? NOTE: A lock is standard on stainless steel units, therefore the key to the lock is taped to the back of the user/install guide. Overlay paneled units will not come with a lock or key.
- Have stainless steel surfaces been inspected for any imperfections? This is to be done by the authorized True dealer or installer with the customer, upon completion of installation. Stainless steel doors, handles and shelves are covered by limited 30-day warranty for cosmetic defects.
- Is the unit operating properly? If not, is the unit plugged in? Is the breaker on? Is the display illuminated and say "off"? For all control operations and sequences please refer to "user interface commands on True Precision control" section in the table of contents per the model of the unit you are installing.
- Does the customer understand the unit's operation?
- Make sure the unit is operating and cooling for 24 hours prior to loading with product. NOTE: loading the unit with some bottles of water will provide assurance the unit is working properly during this 24-hour time-frame.
- Verify all the shelves are securely in place.
- Has the Dual Zone wine unit been connected to an external alarm system? Refer to page (6)

SAFETY PRECAUTIONS

- This refrigerator must be properly installed and located in accordance with the installation instructions before it is used.
- Do not allow children to climb, stand or hang on the shelves in the refrigerator. They could damage the refrigerator and seriously injure themselves.
- Do not store or use gasoline or other flammable vapors and liquids in the vicinity of this or any other appliance.
- Keep hands away from the “pinch point” areas (gaps between the doors and between the doors and cabinet) small areas are not necessarily safe.
- Unplug the refrigerator before cleaning and making repairs.

NOTE: WE STRONGLY RECOMMEND THAT ALL SERVICING BE PERFORMED BY A QUALIFIED INDIVIDUAL.

- Setting temperature control to OFF only removes power from the refrigeration system, it does not remove power from other circuits. For example, temperature control board and lights.

DATA TAG INFORMATION

Data tags are located on the interior upper left hand wall. The serial # is the method we track all pertinent information for the unit.



DEPARTMENT CONTACT INFORMATION

SERVICE DEPARTMENT- SUPPORT AND TRAIN FIELD SERVICE PROVIDERS ON TRUE RESIDENTIAL EQUIPMENT. HELP TROUBLESHOOT AND REPAIR SERVICE ISSUES IN THE FIELD ON TRUE RESIDENTIAL PRODUCTS.

Residential Phone Number : 844-746-9423

Fax : 636-980-8510

Email : Service@truemfg.com

Main Contact: Mike Hurd Mhurd@truemfg.com x1300

Back-up Contact: Dave Swift Dswift@truemfg.com x1387

Hours: Monday-Thursday 7:00AM-7:00PM CST

Friday 7:00AM-6:00PM CST

Saturday 8:00AM-12:00PM CST

WARRANTY DEPARTMENT - ANSWERS QUESTIONS REGARDING A UNITS WARRANTY STATUS. PROCESS WARRANTY CLAIMS FROM SERVICE PROVIDERS.

Residential Phone Number : 844-849-6179

Fax : 636-980-8510

Email: trueresidentialwarranty@truemfg.com

Main Contact: Stephanie Bouxsein x1019

Back-up Contact: Diane Javaux x1005, Eric McIntyre x1023 and Debbie Rogers x1639

Submit Claims to: warrantyresidentialclaims@truemfg.com

Hours: Monday-Friday 7:00AM-6PM CST

PARTS DEPARTMENT - OFFERS NON-WARRANTY PARTS SUPPORT.

Residential Phone Number : 844-849-6226

Fax : 636-272-9471

Email: trueresidentialparts@truemfg.com

Main Contact: Gabriela Lopez x1125

Back-up Contact: Abby Baker x1039

Hours: Monday-Thursday 7:00AM-7:00PM CST

Friday 7:00AM-6:00PM CST

ELECTRICAL SPECIFICATIONS

Do not, under any circumstances, cut or remove the third (ground) prong from the power cord. For personal safety, this appliance must be properly grounded.

To minimize the depth of the cutout opening, the electrical outlet must be positioned as shown below. Outlet must be flush with wall.

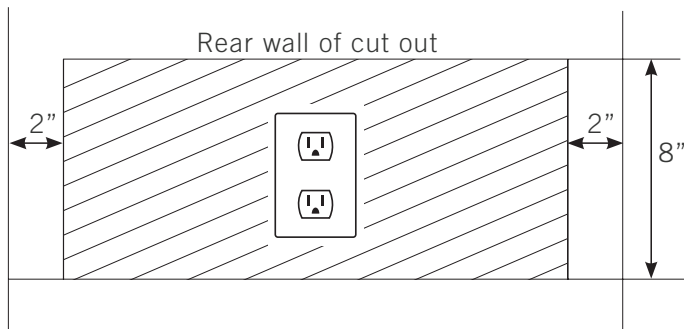

Before your new unit is connected to a power supply, check the incoming voltage with a volt meter. If anything less than 100% of the rated voltage for operation is noted, correct immediately.

The power cord of this appliance is equipped with a 3-prong (grounding) plug which mates with a standard 3-prong (grounding) wall outlet to minimize the possibility of electric shock hazard from this appliance. A 115V AC, 60 Hz, 15 amp circuit breaker and electrical supply are required.

Have the wall outlet and circuit checked by a qualified electrician to make sure the outlet is properly grounded.

If the outlet is a standard 2-prong outlet, it is your personal responsibility and obligation to have it replaced with the properly grounded 3 prong wall outlet.

Do not use an extension cord or two prong adaptor. Electrical ground is required on this appliance.

The unit should always be plugged into its own individual electrical outlet, which has a voltage rating that matches the rating plate. This provides the best performance and also prevents overloading house wiring circuits which could cause a fire hazard from overheated wires. Never unplug your refrigerator by pulling on the power cord. Always grip plug firmly and pull straight out from the outlet.

Repair or replace immediately all power cords that have become frayed or otherwise damaged. Do not use a cord that shows cracks or abrasion damage along its length or at either end. When moving the refrigerator away from the wall, be careful not to roll over or damage the power cord.

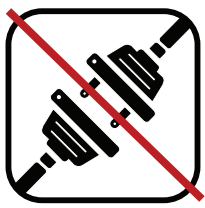

WARNING: COMPRESSOR WARRANTIES ARE VOID IF THE UNIT IS MORE THAN 7 FT. (2.1M) FROM PLUG-IN CONNECTION OR IF AN EXTENSION CORD IS USED.

HOME ALARM SYSTEM - DUAL ZONE WINE CABINET ONLY

Dual Zone wine units are provided with three wires located behind the kick-plate that may be connected to a home alarm system. These connections are for low voltage, low current circuits similar to those used as signals for alarms on doors and windows. Refer to the specifications of your alarm system to determine the type of circuit used.

The color codes for the different circuits are as follows:

- Normally closed contacts: White with black and violet
- Normally open contacts: White with blue and black
- Common: White with black

CAUTION: ANY UNUSED TERMINALS SHOULD BE FULLY INSULATED AND ALL WIRES SHOULD BE SECURED AWAY FROM MOVING PARTS AND SHARP EDGES.



UNCRATING

Required Tools:

- Cutting utensil (utility knife)
- Claw hammer or tin snips

The following procedure is recommended for uncrating the unit:

MOVE YOUR UNIT AS CLOSE TO THE FINAL LOCATION AS POSSIBLE BEFORE REMOVING THE WOODEN SKID.

- Remove nails securing cardboard box to the wooden skid. Then discard any outer packaging (cardboard, clear plastic).
- IMPORTANT:** Cut polyband and remove styrofoam block from underside of the door.
- Remove skid by carefully lifting the refrigerator off and place skid aside.
- Open the unit and remove any packing material. Styrofoam, tape, and any other material used for shipping purposes.

NOTE: KEYS FOR THE LOCK ARE PROVIDED WITH THIS PACKET. STAINLESS STEEL UNITS COME STANDARD WITH LOCKS. OVERLAY PANEL READY UNITS WILL NOT BE EQUIPPED WITH LOCKS.

NOTE: ANTI-TIP BRACKETS KIT AND DOOR STOP ARE PACKED WITHIN THE TOE KICK WHICH IS TAPED TO THE BACK OF THE UNIT. IF THEY ARE NOT IN THE TOE KICK THEY WILL BE PACKAGED INSIDE THE UNIT WITH THIS MANUAL.

FOR ANY MISSING OR BROKEN PARTS. PLEASE CONTACT THE DEALER FROM WHOM YOU PURCHASED THE UNIT.

INSPECT FOR CONCEALED DAMAGE. IMMEDIATELY FILE A CLAIM WITH THE FREIGHT CARRIER IF THERE IS DAMAGE.

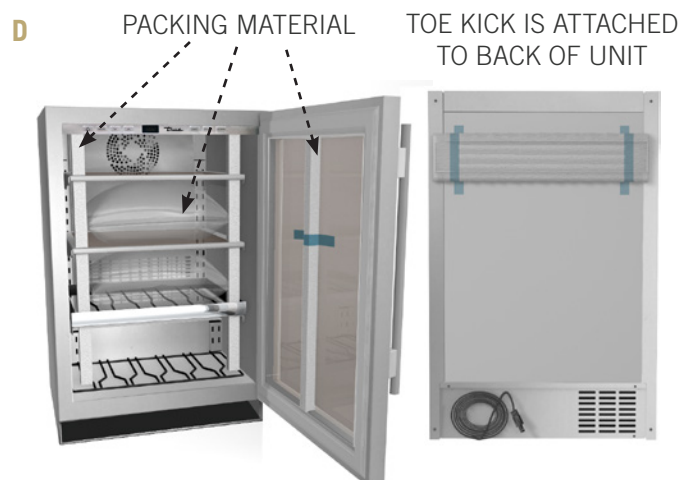
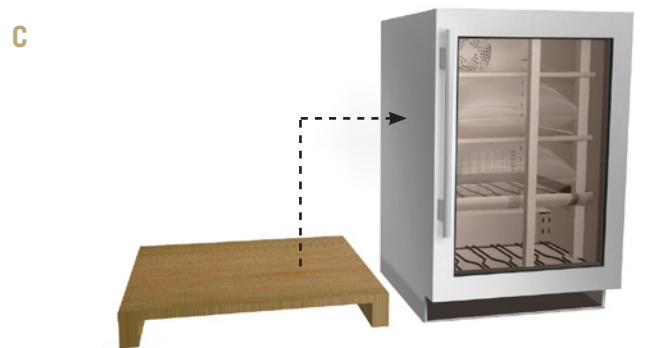
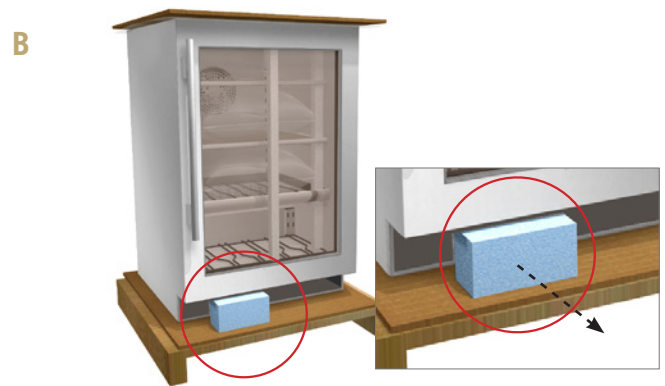

LEVELING THE UNIT

NOTE: PROPER LEVELING OF YOUR TRUE UNIT IS CRITICAL TO OPERATING SUCCESS. EFFECTIVE CONDENSATE REMOVAL AND DOOR OPERATION WILL BE EFFECTED BY LEVELING.

STEP 1 - Move the unit near the final location.

STEP 2 - Level your unit from the interior floor front to back and side to side with a level. If the refrigerator is not level adjust the stainless steel leg levelers. The leg levelers can be adjusted by turning CCW to reach the desired leveling height as shown in the illustration below.

STEP 3 - Free plug and cord from back of unit.

STEP 4 - The unit should be placed close enough to the electrical supply so that extension cords are never used. Plug unit directly into the wall outlet.

STEP 5 - Once installed in final location, re verify level and make final adjustments to the front legs.

STEP 6 - Insert the toe kick on the clips (A) Version or magnets (B) version.

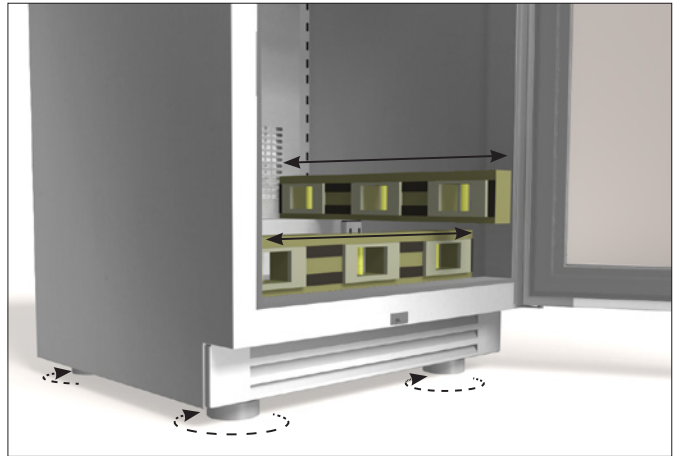

ANTI-TIP BRACKET INSTALLATION

PRODUCT ADVISEMENT

KIT INCLUDES

- 2 Anti-tip brackets
- 4 Concrete screws (blue)
- 4 Wood screws (brass)

TOOLS REQUIRED

- Power drill
- Measuring Tape

IMPORTANT!

ALL FREE STANDING DRAWER (TUR-24D) OR STACKED UNITS MUST HAVE ANTI-TIP BRACKETS INSTALLED.

TIP-OVER HAZARD: A CHILD OR ADULT CAN TIP THE REFRIGERATOR. FAILURE TO FOLLOW THESE INSTRUCTIONS CAN RESULT IN PROPERTY OR BODILY HARM.

BEFORE MOVING UNIT TAKE PRECAUTIONS TO PROTECT THE FLOOR.

Read all installation instructions first. Install the anti-tip brackets to hold both rear legs of the unit. Follow these steps to secure the brackets to the floor before moving the unit into final operating position.

Contact a qualified floor installer for the best procedure of drilling mounting holes through your type of floor.

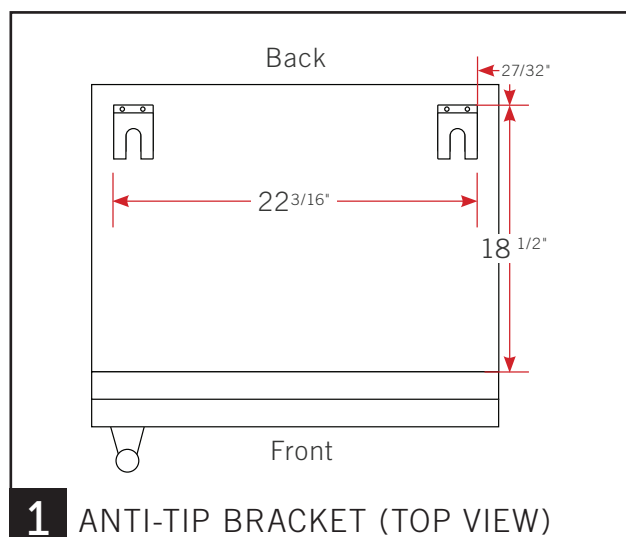

STEP 1

Determine the location of the unit. The anti-tip brackets will be installed $27\frac{3}{32}$ " inset from the back and sides of the unit. You can also measure $18\frac{1}{2}$ " from the front of the unit (not including the lower louver grill). Using the bracket as a template, mark the holes for drilling.

ANTI-TIP BRACKET INSTALLATION

PRODUCT ADVISEMENT

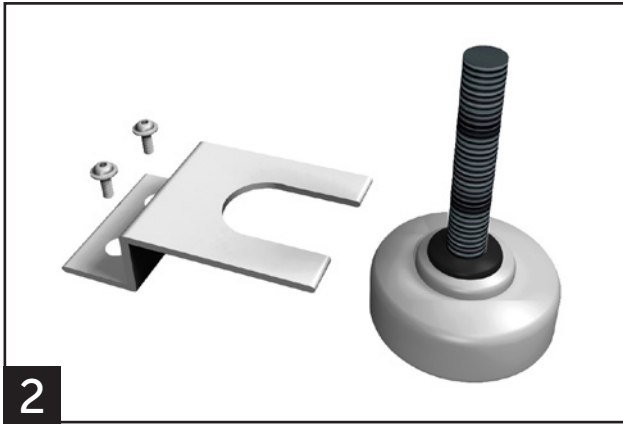

STEP 2

To mount the anti-tip bracket to wood floor, drill pilot holes for each of the bracket holes. To mount the anti-tip bracket to concrete or ceramic floor use a masonry bit to drill pilot holes. Align anti-tip bracket holes with the holes in the floor. Fasten anti-tip bracket with screws provided using the brass colored screw for wood, or blue colored masonry screw for concrete.

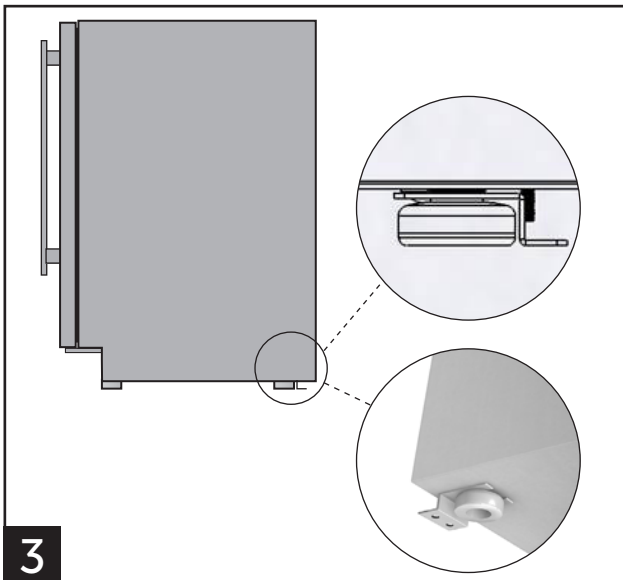

STEP 3

Move unit into final position making sure rear leveling legs slide into the anti-tip brackets.

DOOR STOP INSTALLATION

INSTRUCTIONS FOR STAINLESS STEEL MODELS

ALL UNITS ARE PROVIDED WITH AN OPTIONAL DOOR STOP. WHEN INSTALLED, THE DOOR STOP WILL PREVENT DAMAGE TO SURROUNDING CABINETS BY RESTRICTING THE DOOR FROM OPENING PAST APPROXIMATELY 120° WITH A STANDARD HINGE OR 90° WITH AN 90° HINGE (OPTIONAL).

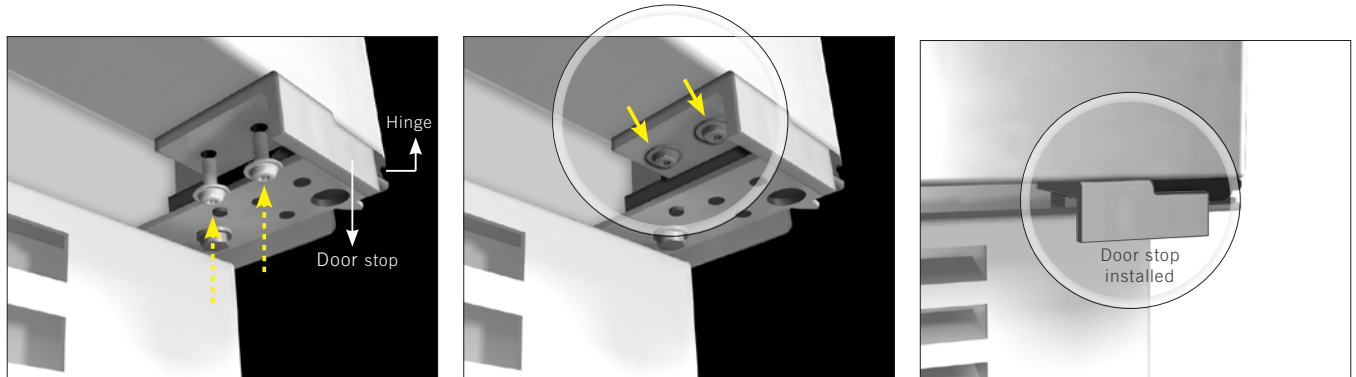

STEP 1

To install the door stop, use the 2 screws provided and secure the bracket to the bottom of the door on the same side as the hinge.

(OPTIONAL) 90° HINGE INSTALLATION

INSTRUCTIONS FOR STAINLESS STEEL MODELS

KIT INCLUDES

- 90° Hinge (left or right)
- Door stop bracket (left or right)

TOOLS REQUIRED

- 3/8" Socket wrench
- Phillips screwdriver



STEP 1

Remove toe kick.

(OPTIONAL) 90° HINGE INSTALLATION

INSTRUCTIONS FOR STAINLESS STEEL MODELS

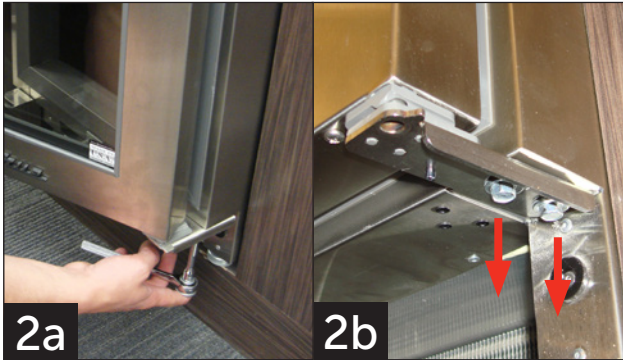

STEP 2

WARNING: Support the door while removing hinge. Door is heavy and weight will cause it to drop if not supported.

Remove 2 3/8" bolts to detach 120° door hinge (standard).



STEP 3

Slowly remove door from unit by sliding down from top hinge.

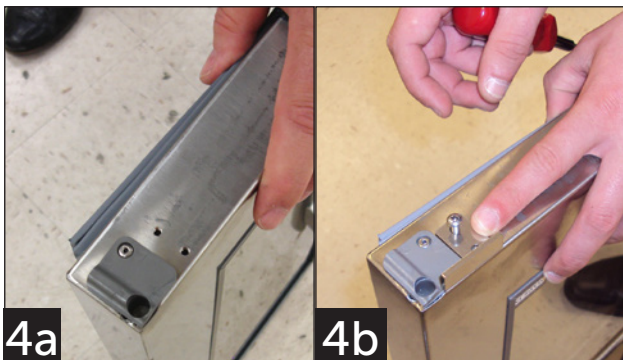

STEP 4

Install door stop using screws already installed. Reinstall door by sliding up into top hinge.

(OPTIONAL) 90° HINGE INSTALLATION

INSTRUCTIONS FOR STAINLESS STEEL MODELS



STEP 5

Install 90° hinge with the 2 3/8" bolts that you removed. Note: Do not tighten screws all the way until door adjustments have been made.



STEP 6

Align door with lock latch and light switch. Tighten screws.

DRAWER DEPTH ADJUSTMENT

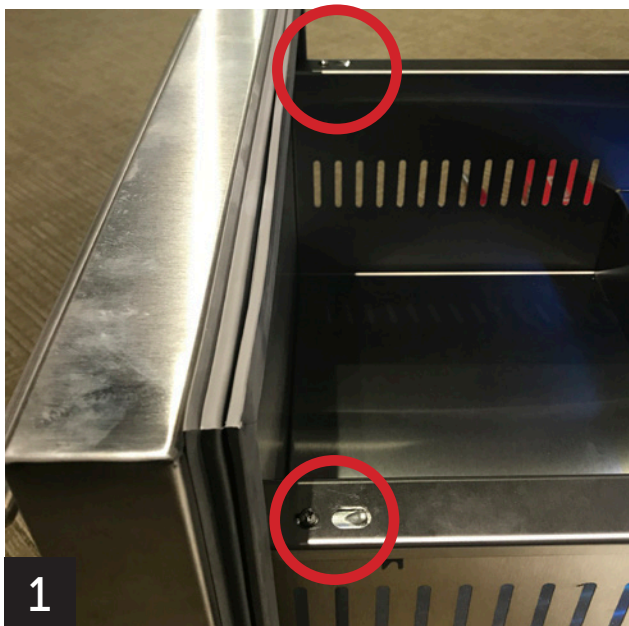

STEP 1

Loosen the left and right screws that mount the drawer frame to the slide. See Image 1.

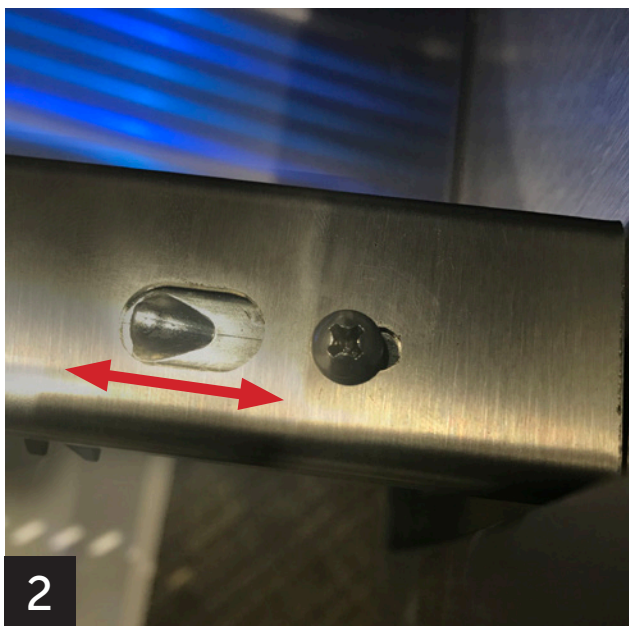

STEP 2

To bring the drawer out to the front of the unit, pull the drawer out where the tab is seated towards the rear of the unit. See Image 2.

STEP 3

Hold drawer position and tighten screws.

DRAWER FRONTS ON TRUE DRAWER REFRIGERATORS ADJUSTMENT

STEP 1 - Open the drawer that needs adjustment.

STEP 2 - Locate the two Phillips screws on each side of the drawer frame. See figure 1

STEP 3 - Loosen the 2 screws on each side to get left to right movement on the drawer front.

STEP 4 - Hold adjustment in place and re tighten the screws back down.

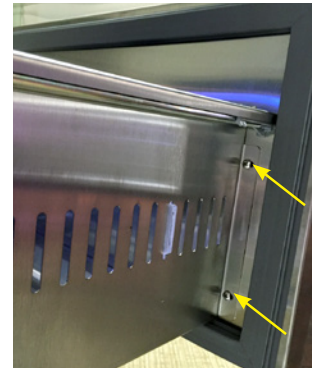

FIGURE 1.

DRAWER GLIDES ON TRUE DRAWER REFRIGERATORS ADJUSTMENT

STEP 1 - Remove screws (one on each side) on top of drawers at front.

STEP 2 - Remove drawers (lift out from the front)

STEP 3 - Loosen the two screws on the glide

STEP 4 - Use bottom screw to adjust glide

STEP 5 - Tighten side screws

STEP 6 - Replace drawer by aligning into tabs (in back)

STEP 7 - Reinsert screws in front

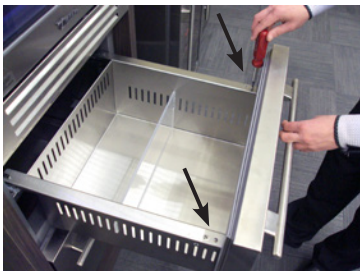

1



2

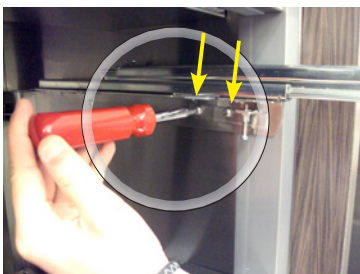

3



4

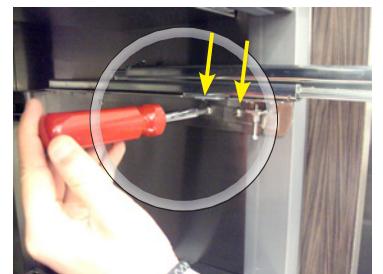

5



6

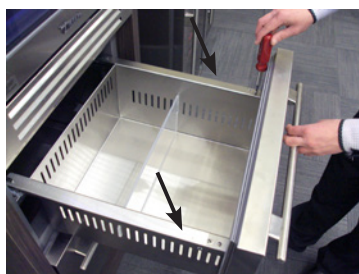

7

DOOR REMOVAL

STEP 1 - Remove the louver grill from the bottom of the unit by simply pulling the grill toward the front of the unit. See image 1.



1

STEP 2 - Support the door with your knee or a block to prevent the door from falling to the ground when the bolts are removed.

STEP 3 - Remove the two 3/8-inch bolts from the bottom hinge using a ratchet and socket. See image 2A and 2B.



2A

2B

STEP 4 - Pull the hinge out of the bottom of the door and set it aside.

STEP 5 - Once these two bolts are removed, slightly open the door, still supporting the weight with your knee or a block, slowly allow the door to drop down off the top hinge pin. See image 3.



3

STEP 6 - Reinstall door by reversing sequence.

STAINLESS STEEL & STAINLESS GLASS DOOR ADJUSTMENTS

ALL VERSIONS

PLEASE NOTE: DOOR HINGING ON TRUE PRODUCTS ARE NOT INTERCHANGEABLE. IT IS NEVER RECOMMEND TO ATTEMPT MOVING DOOR HINGING TO THE OPPOSITE SIDE THE UNIT WAS BUILT WITH. THIS MAY CAUSE SERIOUS DAMAGE AND HARM.

STEP 1 - Make sure the unit is completely level and in place.

STEP 2 - Remove the bottom louver grill from the unit. See image 1.

NOTE: A version grills are clipped in and B version grills are held on with magnets.

STEP 3 - With the door shut loosen the two 3/8-inch bolts. See image 2.

STEP 4 - While supporting the door, open slightly and shift the door up or down on the handle side. See image 3.

STEP 5 - Hold the adjusted door and retighten the two 3/8 inch bolts until very snug to prevent the adjustment from coming loose.

STEP 6 - Test the door by opening and closing, making sure the door is not hitting the lock latch (image 4a) and ensure that the door makes contact with the door switch (image 4b).

STEP 7 - Re-install the louver grill.



1



2



3

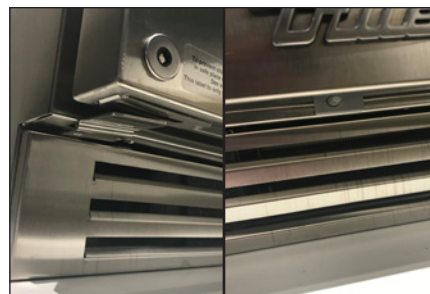

4A

4B

OVERLAY PANEL & OVERLAY PANEL GLASS DOOR ADJUSTMENTS

PLEASE NOTE: DOOR HINGING ON TRUE PRODUCTS ARE NOT INTERCHANGEABLE. IT IS NEVER RECOMMEND TO ATTEMPT MOVING DOOR HINGING TO THE OPPOSITE SIDE THE UNIT WAS BUILT WITH. THIS MAY CAUSE SERIOUS DAMAGE AND HARM.

DOOR ADJUSTMENT UP AND DOWN - ALL VERSIONS

STEP 1 - Make sure the unit is completely level and in place.

STEP 2 - Remove the bottom louver grill from the unit. See image 1.

NOTE: A version grills are clipped in and B version grills are held on with magnets.

STEP 3 - With the door shut loosen the two 3/8-inch bolts. See image 2 and 3.

STEP 4 - While supporting the door, open slightly and shift the door up or down on the handle side. See image 4.

STEP 5 - Hold the adjusted door and retighten the two 3/8 inch bolts until very snug to prevent the adjustment from coming loose.



1



2

3



4

DOOR ADJUSTMENT LEFT TO RIGHT

STEP 1 - Loosen the top and bottom Phillips screws (do not remove screws unless you want to remove the door). See image 5 and 6.

STEP 2 - Shift the entire door left or right to align to desired position. See image 7.

STEP 3 - While holding the door in position re-tighten the upper and bottom screws to hold new adjustment.

STEP 4 - To adjust the upper only, loosen the two screws on the upper hinge bracket and shift door accordingly. See image 5.

STEP 5 - To adjust the bottom only, loosen the two screws on the bottom hinge bracket and shift door accordingly. See image 6.

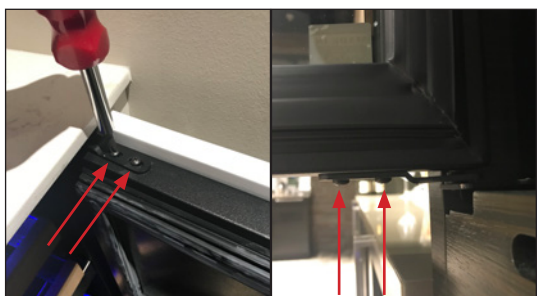

5

6



7

WINE SHELVING ADJUSTMENT

The glide out wine shelves in TBC, TWC and TWZ-DZ models consist of 3 pieces. These pieces are the wire wine rack and 2 mounting bracket/glide assemblies (one for the hinge side and one for the non-hinge side).

To remove the wine shelf, pull up on the front of the wine rack and it will separate from the two mounting brackets. The two mounting brackets may now be removed from the pilasters by lifting straight up then pulling the brackets out of the pilasters.

NOTE: WHEN REINSTALLING THE BRACKETS, THE BRACKET WITH THE LARGER VIBRATION BUMPER MUST BE INSTALLED ON THE SAME

SIDE OF THE CABINET AS THE DOOR HINGE. WHEN REINSTALLING THE WINE RACK, BE SURE THAT THE BACK OF THE RACK HOOKS UNDERNEATH THE TAB ON THE GLIDE.

The tab on the front of the glide must also fit securely in the gap between the handle and the rack (see illustration). If the fit is too tight, you may need to loosen the screws on the back of the handle to increase the gap.

The wine shelves are held securely by the anti-vibration bumpers. If there is too much play side-to-side, tighten the bumpers against the compartment walls by rotating with your fingers.

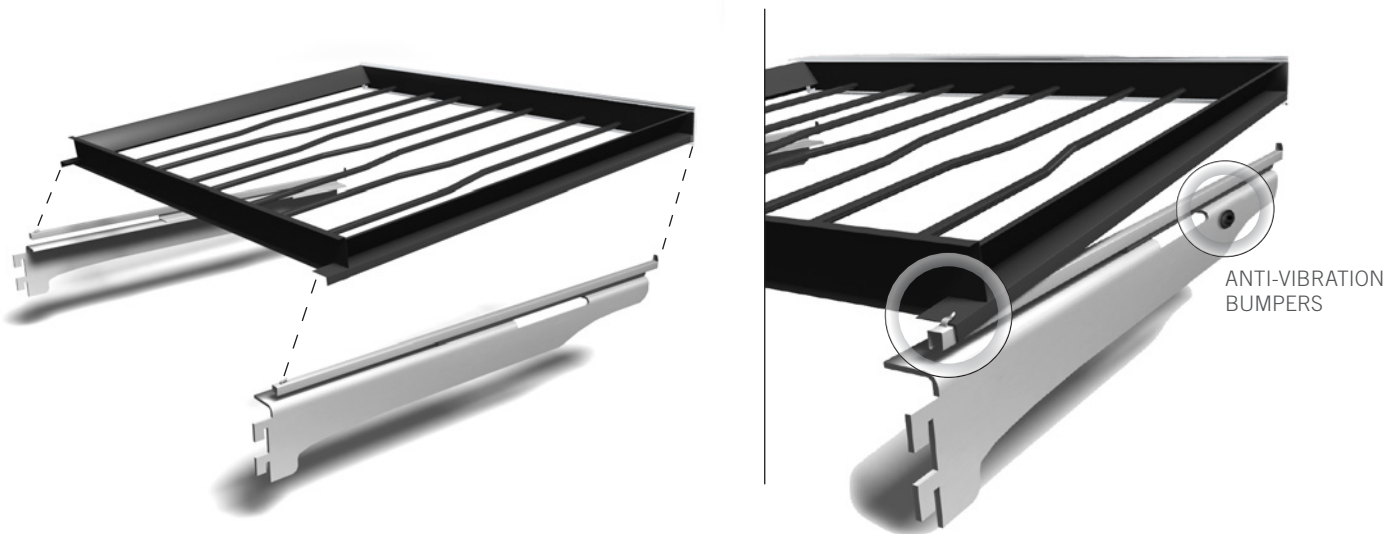

GLASS SHELVING ADJUSTMENT

The glide out glass shelves are already attached to the mounting bracket/glide assemblies.

To install the glass shelves insert mounting brackets into pilasters.

To remove the glass shelves, simply lift straight up then pull the brackets out of the pilasters.

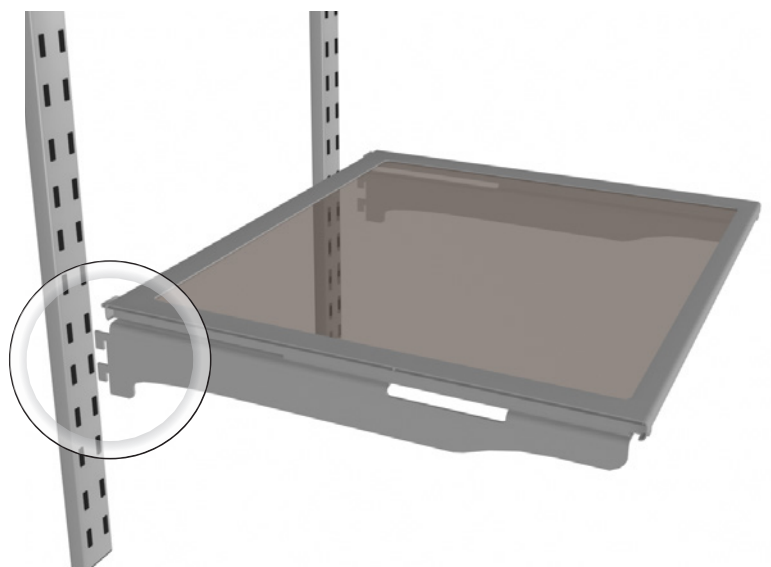

LED LIGHTING

- The lighting in all True Residential® Undercounter Models is an LED module system.
- Each compartment has 1 or 2 LED modules that are powered by a driver.
- The modules have an IC chip in them to change their color. A short power interruption is the trigger to change the color.
- If the colors are ever out of sync, they can be reset by changing the color 10 times in a row. This will reset all modules back to white.
- The LED modules run off a 10V DC power supply which is located next to the microprocessor control. The power supply has 115V AC incoming, then 10V DC outgoing.

WHEN LIGHTS ARE SET TO GO OFF WHEN THE DOOR IS SHUT, 30 SECONDS LATER THE LED'S WILL HAVE A SPLIT SECOND FLASH. THIS IS BY DESIGN TO ALLOW THE LED'S TO RELEASE STORED ELECTRICITY. IT WILL DO THIS ONLY ONE TIME, EACH TIME THE DOOR IS SHUT.

IF THE LIGHTS ARE SET TO STAY ON EVEN WHEN THE DOOR IS SHUT, THIS WILL NOT OCCUR.



STACKING KIT INSTRUCTIONS

PRODUCT ADVISEMENT

KIT INCLUDES

- (1) Louver grill. Note: A version models will use clips to mount the grill. B version models will have magnets.
- (2) stacking brackets
- (4) 5/16 inch screws
- Anti-tip bracket kit

TOOLS REQUIRED

- 5/16-inch socket and ratchet
- Level
- Floor proctor
- Extra person(s)

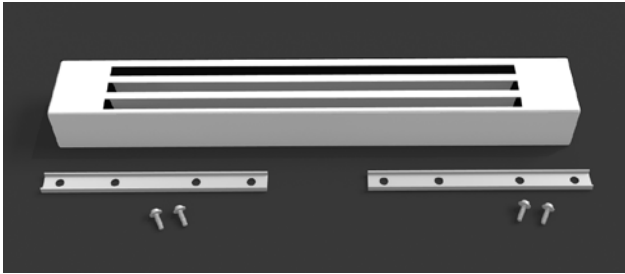

PROTECT THE FLOOR, SURROUNDING CABINETRY AND THE UNITS AT ALL TIMES.

- Uncrate and secure doors, shelving, and drawers to prevent damage when handling the units.
- Install the anti-tip bracket per instructions (see separate).
- Verify the anti-tip brackets are properly located by trial fitting the lower unit in place. If so pull the unit back out to prepare Step 1.

THIS PROCEDURE REQUIRES ASSISTANCE FROM EXTRA PERSON(S).

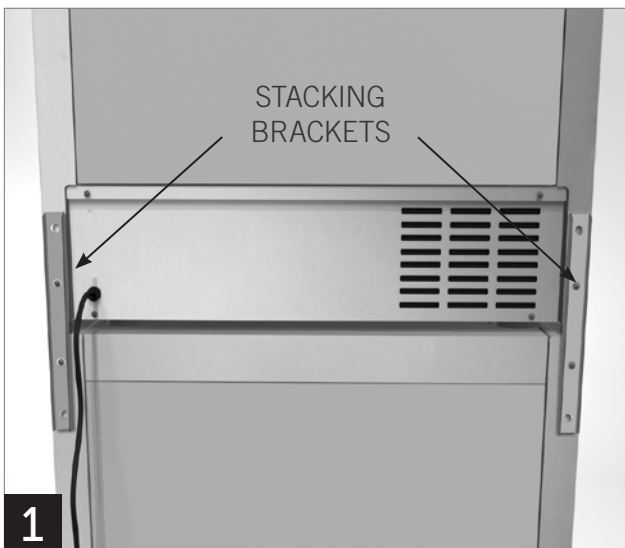

STEP 1

Carefully lift the top cabinet and place on the lower cabinet making sure the upper unit is flush with the lower unit's sides and back.

STEP 2

Install the rear stacking brackets using the provided 5/16-inch screws. NOTE: DO NOT TIGHTEN THE BRACKETS ALL THE WAY UNTIL LATER STEPS. See Image 1.

STACKING KIT INSTRUCTIONS

PRODUCT ADVISEMENT



STEP 3

Level the upper and lower unit front to back and left to right by placing a small level on the interior floor. See Image 2.

STEP 4

Now tighten all (4) 5/16-inch screws to secure the brackets to the units.

STEP 5

Carefully put the stacked units in their final setting. Make sure the bottom unit's rear legs are securely locked into the anti-tip brackets.



STEP 6

Install supplied louver grill on upper unit. See Image 3.

24 INCH



TECHNICAL DATA

SOFTWARE INFORMATION AND START UP MODE

SEQUENCE OF OPERATION

USER INTERFACE COMMANDS

DEFROST

EVAPORATOR COVER REMOVAL

EVAPORATOR SECTION LAYOUT

PROBE VALUES

EVAPORATOR FAN DRIVER

CONTROL BOARD REPLACEMENT & MODEL SELECT SEQUENCE OF OPERATION

WIRING DIAGRAMS



SOFTWARE INFORMATION AND START UP MODE

All software codes will be displayed every time the machine is powered up (power must be disconnected) – the software code will be displayed for a minimum of 25 seconds. (Does not apply to ice machine or uprights)

1) Software Version: 66 (does not apply to ice machine or uprights)

- Only used for A version models (Model number will finish with the letter “A”)



Example:

MODEL	SIZE	HINGE	DOOR	EDITION
TWC	24DZ	L	SG	A
TRUE WINE CABINET	24" DUAL ZONE	HINGED ON LEFT HANDLE ON RIGHT	STAINLESS GLASS	

2) Software Code: 73 (does not apply to ice machine or uprights)

- Only used for B version models (Model number will finish with the letter “B”)
- This software code was replaced by software version: 94
- If a control board has software code “73” and fails, will be replaced with new software version “94”



Example:

MODEL	SIZE	HINGE	DOOR	EDITION
TWC	24DZ	L	SG	B
TRUE WINE CABINET	24" DUAL ZONE	HINGED ON LEFT HANDLE ON RIGHT	STAINLESS GLASS	SECOND REVISION

3) Software Code: 94 (does not apply to ice machine or uprights)

- Currently used on B version models (Model number will finish with the letter “B”)
- Software version “94” has a hard-reset option. A hard reset will eliminate the need to disconnect power to the unit to verify software and program the model when needed.



Example:

MODEL	SIZE	HINGE	DOOR	EDITION
TWC	24DZ	L	SG	B
TRUE WINE CABINET	24" DUAL ZONE	HINGED ON LEFT HANDLE ON RIGHT	STAINLESS GLASS	SECOND REVISION

HARD-RESET PROCEDURE

In order to perform a hard-reset of the machine please follow these steps:

i. Turn the unit Off using the power button (hold for 3 seconds)

ii. Press and hold the  + 

iii. A successful hard-reset will show a 3-digit code for 25 seconds followed by “94” for 20 seconds. After a total of 45 seconds, compartment temperature will be displayed.

HARD-RESET FEATURE MAY NOT FUNCTION FOR ALL B VERSION UNITS. IF THE DISPLAY CONTINUES TO SHOW “OFF” AFTER PERFORMING A HARD-RESET.

SEQUENCE OF OPERATION

The operating system consist of these components.

ELECTRONIC CONTROL BOARD – Main control of the entire unit’s functionality. The control board is located in the interior ceiling for all models except (TUF & DZ) TUF board location is behind the rear back cover. DZ boards are located in the interior ceiling of the center mullion.

COMPRESSOR – Variable speed and single speed compressors depending on version. Please see page 47

CONDENSER FAN MOTOR – Located behind the rear panel of the unit. The condenser fan should always run while the compressor is running.

24" units - 120VAC condenser fan motor

15" units - 10VDC condenser fan motor

EVAPORATOR FAN MOTOR – Located behind the interior back cover. The evaporator fan motor will cycle off with the refrigeration cycle on refrigerators. On wine units the evaporator fan will run all the time. The fan will always shut off when the door is opened.

ONE COMPARTMENT PROBE (Labeled with two blue stripes on "A"versions) (solid blue on "B"versions) – this sensor controls the cut in and cut out of the refrigeration system.

ONE EVAPORATOR PROBE (Labeled with 1 blue stripe on "A"versions) (solid blue on "B"versions) – this sensor controls the defrost function. (Described in detail in the "Defrost" section of this manual)

When power is supplied, the LCD will show a software version code for a minimum of 25 seconds. This is for manufacturing process only.

From the “off” to the "on" position using the interface power button, the following will happen:

1. Interior LED lights will illuminate.
2. Display readout will show interior cabinet temp based off the compartment probe.
3. After a 2-minute delay the refrigeration system will start.

The refrigeration system (compressor, condenser fan motor, evaporator fan motor) will run until cut out temperature is reached.

PLEASE NOTE: THE CUT OUT TEMPERATURE IS BASED ON THE COMPARTMENT PROBE, NOT THE DISPLAY TEMPERATURE. OUR DISPLAY TEMPERATURE IS A CALCULATION AND IS NOT REFLECTING REAL TIME TEMP.

Once the cut out temperature is reached the we will shut the refrigeration system off.

The cycle will repeat when the compartment probe tells the control board to cut back in.

NOTE: THE CONTROL HAS A PRESET 7 MINUTE ANTI SHORT CYCLE.

DUAL ZONE

The TWC-24DZ has two zones which can be independently set for different temperatures.

Each zone has its own display, evaporator coil, evaporator fan and probes.

The zones share the compressor, condenser coil, and condenser fan motor.























Refrigerant is directed to either zone through a bi-stable solenoid valve.

Only one zone can be cooled at a time.









































The control continually checks to see which zone is demanding for cooling. If both zones need cooling, the control will switch from cooling one zone to the other every 20 minutes.

NOTE: THE UPPER ZONE HAS PRIORITY WHEN THE CABINET IS FIRST POWERED ON AND WILL ONLY START TO COOL THE LOWER AFTER THE UPPER ZONE SET POINT HAS BEEN MET (ONLY ON START UP)

USER INTERFACE COMMANDS ON TRUE PRECISION CONTROL®

KEY COMBINATIONS	LCD READOUTS	DESCRIPTION
 On/Off (hold 3 seconds)		Power unit off / on.
 Set Point		Press and release to show set point for 5 seconds. After 5 seconds the display will resort back to average box temp. NOTE: 15 inch units use "up" or "down" button
 Decrease Set Point		Press to decrease set point. Minimum set points: 33°F - Refrigerators 40°F - Wine Units -4° F - Freezer
 Increase Set Point		Press to increase set point. Maximum set points: 47°F - Refrigerators 65°F - Wine Units -4° F - Freezer
 Accent Light		Turn accent light on/off. When icon is displayed, light remains on at all times.
 Color		Press and release the button combination to start the color cycle. Press and release the button combination again to choose the desired color. NOTE: Dual Zone models will use "mode + light" NOTE: 15 inch models will use "light + up arrow" NOTE: "A" version has 3 colors.
 Alarm		Activates / deactivates alarm NOTE: 15 inch units use "POWER + DOWN"
 Temperature Scale		Toggle between °C / °F. 24 inch models only
 Lock		Lock / Unlock Keypad.
 Sabbath Mode		Sets Sabbath mode – Star K certified. Kosher compliant. NOTE: 15 inch units use "light" button
 Showroom Mode		Display set point. Lights are fully functional. Deactivates refrigeration system. Disables power off function. NOTE: 15 inch units use "light" button

USER INTERFACE COMMANDS ON TRUE PRECISION CONTROL®

KEY COMBINATIONS	LCD READOUTS	DESCRIPTION
 +  Hard Reset (hold 3 sec)		To initiate hard reset, unit must be in the "off" position. This feature is used to reset the control. NOTE: 15 inch units use "light" button Note: 94V only.
 +  Initiate Manual Defrost (freezer only)		Defrost will terminate at the following temperature or time. Termination temperature: 40°F Termination time: 30 minutes NOTE: 94 V only
Refrigeration Error	    °F °C	Unit has not reached desired set point after 15 hours of run time. Service recommended. Power unit off and back on to reset.
Compartment Probe Failure (Upper zone on DZ)	    °F °C	Cycle off evaporator probe using a 2° degree offset NOTE: 94 V only
Evaporator Probe Failure (Upper zone on DZ)	    °F °C	Each time the unit calls for cooling, we will run the evaporator fan for 10 minutes before running the compressor. NOTE: 94 V only
Compartment and Evaporator Probes Failed (Upper zone on DZ)	    °F °C	Unit will run in safe mode as follows: 10 minutes off / 10 minutes evaporator fan only 10 minutes fan and compressor Cycle repeats until both probes are changed NOTE: 94 V only
High Temperature Alarm	    °F °C	Set high temperature alarm. High Temps (1 consecutive hour): 50°F - Refrigerator / 70°F - Wine Cabinet NOTE: 94 V only
Door Ajar Alarm	    °F °C	Door is ajar (7 minutes) NOTE: 94 V only
Compartment Probes Failure DZ Only (Lower zone)	    °F °C	Cycle off evaporator probe using a 2° degree offset NOTE: 94 V only
Evaporator Probe Failure DZ Only (Lower zone)	    °F °C	Each time the unit calls for cooling, we will run the evaporator fan for 5 minutes before running the compressor. NOTE: 94 V only
Compartment and Evaporator Probes Failed DZ Only (Lower zone)	    °F °C	Unit will run in safe mode as follows: 10 minutes off / 10 minutes evaporator fan only 10 minutes fan and compressor Cycle repeats until both probes are changed NOTE: 94 V only

DEFROST SEQUENCE OF OPERATION

- 1) 7-minute anti-short cycle has elapsed.
- 2) Compartment probe reaches the cut-in point.
- 3) Control board checks the evaporator coil temperature probe. If the evaporator coil probe is below 38°F the evaporator fan will start and run while the compressor and condenser fan remain off.
- 4) Once the evaporator coil probe reaches 38 °F, the control will allow the compressor and condenser fan motor to run until cut out temperature is reached.
- 5) This process will be repeated upon each call for cooling.



NOTE: – Wine units run the evaporator fan(s) all the time.

FREEZER MODELS ONLY

- 1) Three methods of initiating defrost:

a) the control reached the max compressor run time (60 hours)

b) the evaporator probe has reached -25°F.

c) initiate manual defrost by pressing and holding  +  for 3 seconds
Initiate Manual Defrost

NOTE: – The control will prohibit defrost the first 4 hours of plugging the unit in.

- 3) Compressor, evaporator fan and condenser fan shut off during defrost.
- 4) The drain tube heater, evaporator coil heater and drain trough heater will energize until time or temperature is met.
 - a) Maximum defrost run time is 30 mins.
 - b) termination temperature is 40 degrees based off evaporator probe temperature.
- 5) While in defrost, the display will continue to show temperature which is filtered and will not reflect normal fluctuation.

NOTE: – The only time the display will show "def" is when a manual defrost is initiated by pressing and holding



- 6) Once the defrost cycle ends, the control board will delay the following components:
 - a) Delay compressor after defrost - 2 minutes.
 - b) Delay evaporator fan motor after defrost - 6 minutes.

EVAPORATOR COVER REMOVAL

A VERSION

- Remove all shelves from the unit.
- Remove two Phillips screws on upper part of evaporator cover.
- Slide cover down and out.



EVAPORATOR COVER REMOVAL

B VERSION

- Remove all shelves from the unit.
- Remove two Phillips screws on upper part of evaporator cover. See Picture 1
- Slide the cover down and pull out.

NOTE: YOU MAY NEED TO LIFT UP ON THE LEFT AND RIGHT SHELF STANDARD WITH A SCREWDRIVER. PLEASE SEE PICTURE 2.

Loosening the shelf standard may be necessary if lifting wasn't successful. Remove the top gray cap and loosen the screw, do not remove the screw. See Picture 3.

PICTURE 1

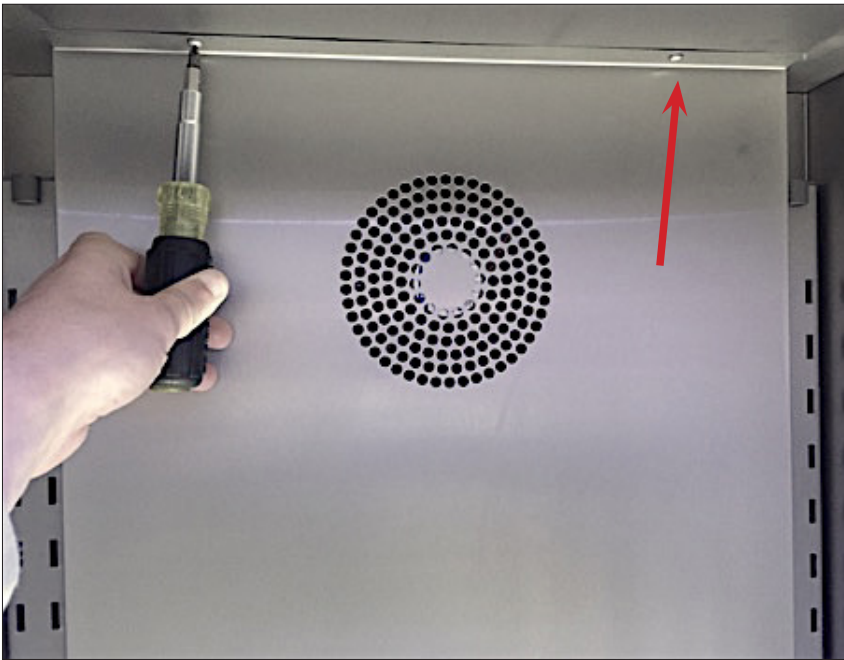

PICTURE 2



PICTURE 3



EVAPORATOR SECTION LAYOUT

A VERSION

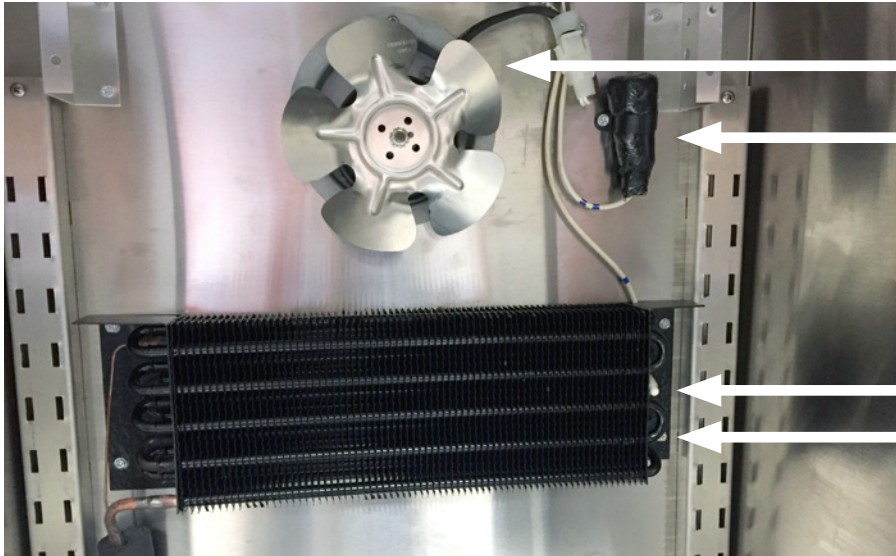

EVAPORATOR FAN MOTOR AND BLADE

COMPARTMENT PROBE
(2 BLUE STRIPES)

EVAPORATOR PROBE (1 BLUE STRIPE)

EVAPORATOR COIL

EVAPORATOR SECTION LAYOUT

B VERSION

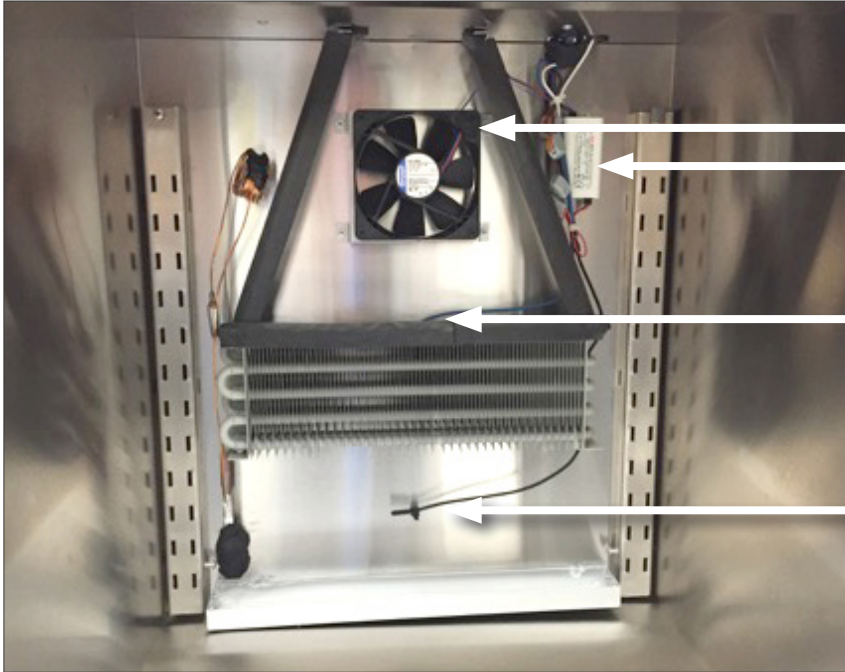

EVAPORATOR FAN MOTOR
EVAPORATOR FAN MOTOR DRIVER

BLUE PROBE – DEFROST ASSIST PROBE

BLACK PROBE – CUT IN & CUT OUT

PROBE VALUES

T (F°)	Ω
14°	55.3K
23°	42.3K
32°	32.6K
41°	25.3K
50°	19.9K
59°	15.7K
68°	12.5K
77°	10K
86°	8K
95°	6.5K
104°	5.3K

EVAPORATOR FAN DRIVER

The evaporator fan motor driver is located directly next to the evaporator fan.

The motor driver will have 120V AC coming in and 12V DC going to the motor.

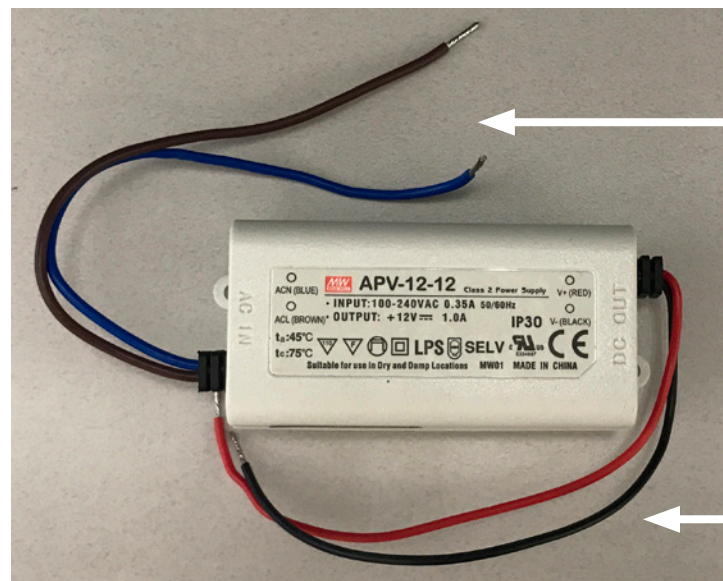

120V AC

12V DC

CONTROL BOARD REPLACEMENT & MODEL SELECT SEQUENCE OF OPERATION



A SINGLE ZONE ONLY

The control is located in the interior ceiling on single zone models (see images A & B). Control is located in the lower compartment ceiling of dual zone models (see image C). Remove Phillips screws that hold the control board cover.

Power should always be disconnected from the unit prior to changing the control board. This will require unplugging the unit and / or shutting the breaker off.

DO NOT apply power to the unit until you are ready to program per table below.

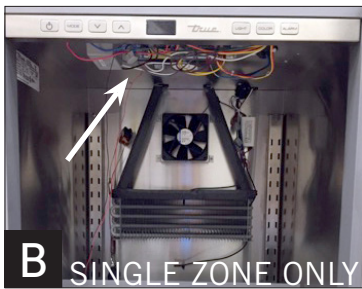

B SINGLE ZONE ONLY

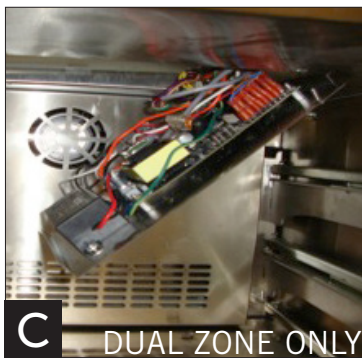

C DUAL ZONE ONLY

MODEL SELECT SEQUENCE OF OPERATION

Since the same control board is used on multiple models it is necessary to set up the control to the proper code for the model you are working on.

1. Reconnect power to the unit.
2. Once power is supplied, the control board will display a 3-digit code.
3. Within 30 seconds of applying power, press and hold the power button until you see "0" or "000".
4. Release the power button and use the up arrow to scroll up until you find the code for the model you are working on. See table below.
5. Wait for the display to time out until the compartment temperature is displayed. Programming is now complete.
6. After a 2-minute delay, all components will start and run until the set point is reached.

NOTE: If you miss step 3 in allowed time, the model select sequence will not function and you will have to reset power to the unit.

All B version replacement boards have a hard-reset option to initiate the programming sequence.

HARD-RESET PROCEDURE

1. Press and hold the power button until the display reads "OFF".
2. Press and hold the MODE + UP buttons at the same time until "OFF" disappears. A 3-digit code will be displayed. Immediately move to step 3.
3. Press and hold the power button for a minimum of 15 seconds until "0" is displayed.
4. Release the power button and use the up arrow to scroll up until you find the code for the model you are working on. See table below.
5. Wait for the display to time out until the compartment temperature is displayed. Programming is now complete.

MODEL A VERSION	MODEL B VERSION	CODE
TUR-24-A TBC-24-A TUR-24BD-A TUR-24DD-A	TUR-24-B TBC-24-B TUR-24BD-B TUR-24DD-B	101
TUR-24D-A	TUR-24D-B	102
TWC-24-A	TWC-24-B	001
TWC-24DZ-A	TWC-24DZ-B	300
TUR-15-A	TUR-15-B	105
TWC-15-A	TWC-15-B	002
	TUF-24-B	200

* NOTE: Same codes for A and B versions.

WIRING DIAGRAM

PART NUMBER 958860 TRUE UNDERCOUNTER DRAWERED UNIT

"A" VERSION

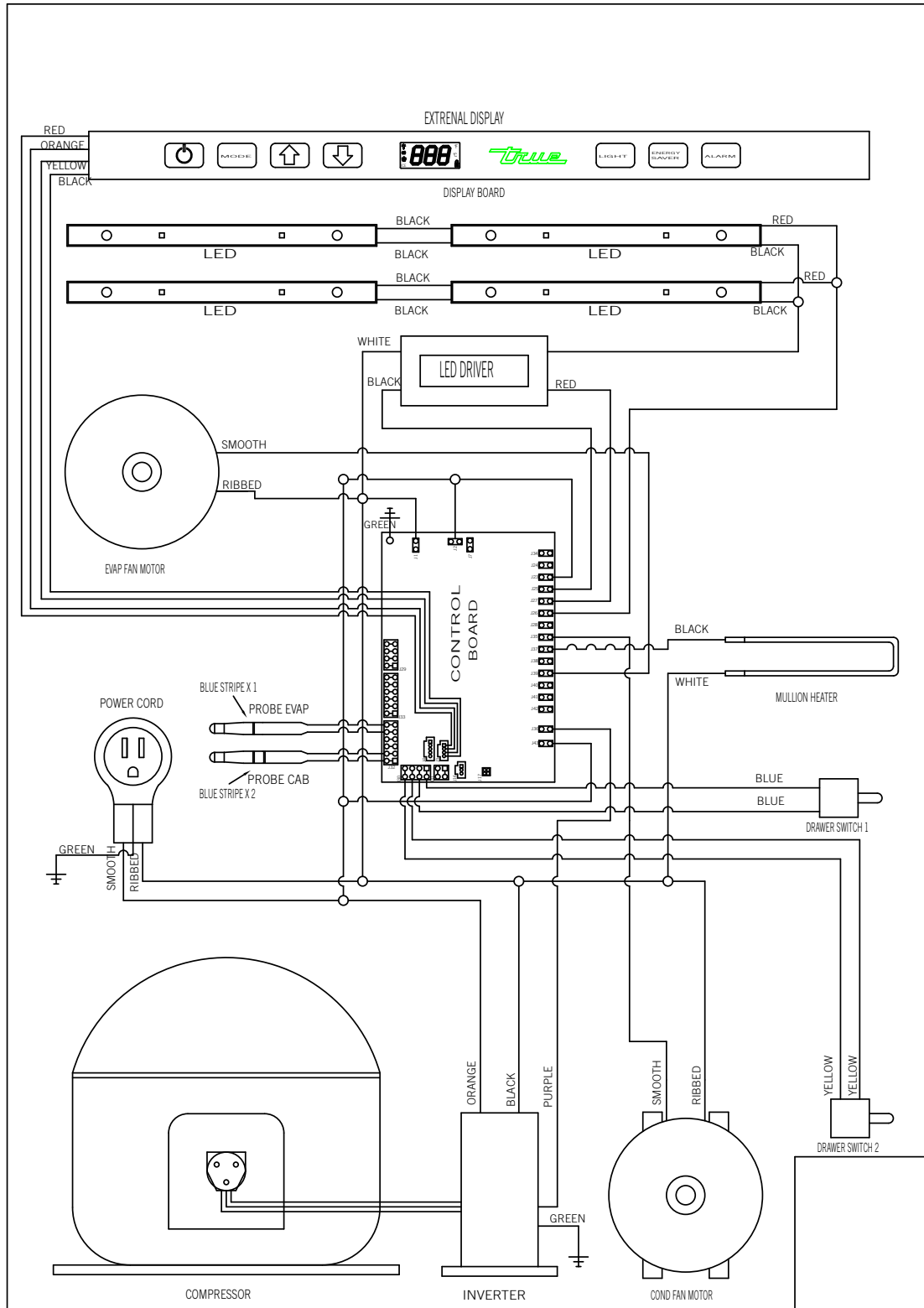

WIRING DIAGRAM

PART NUMBER 958860 TRUE UNDERCOUNTER DRAWERED UNIT

"A" VERSION

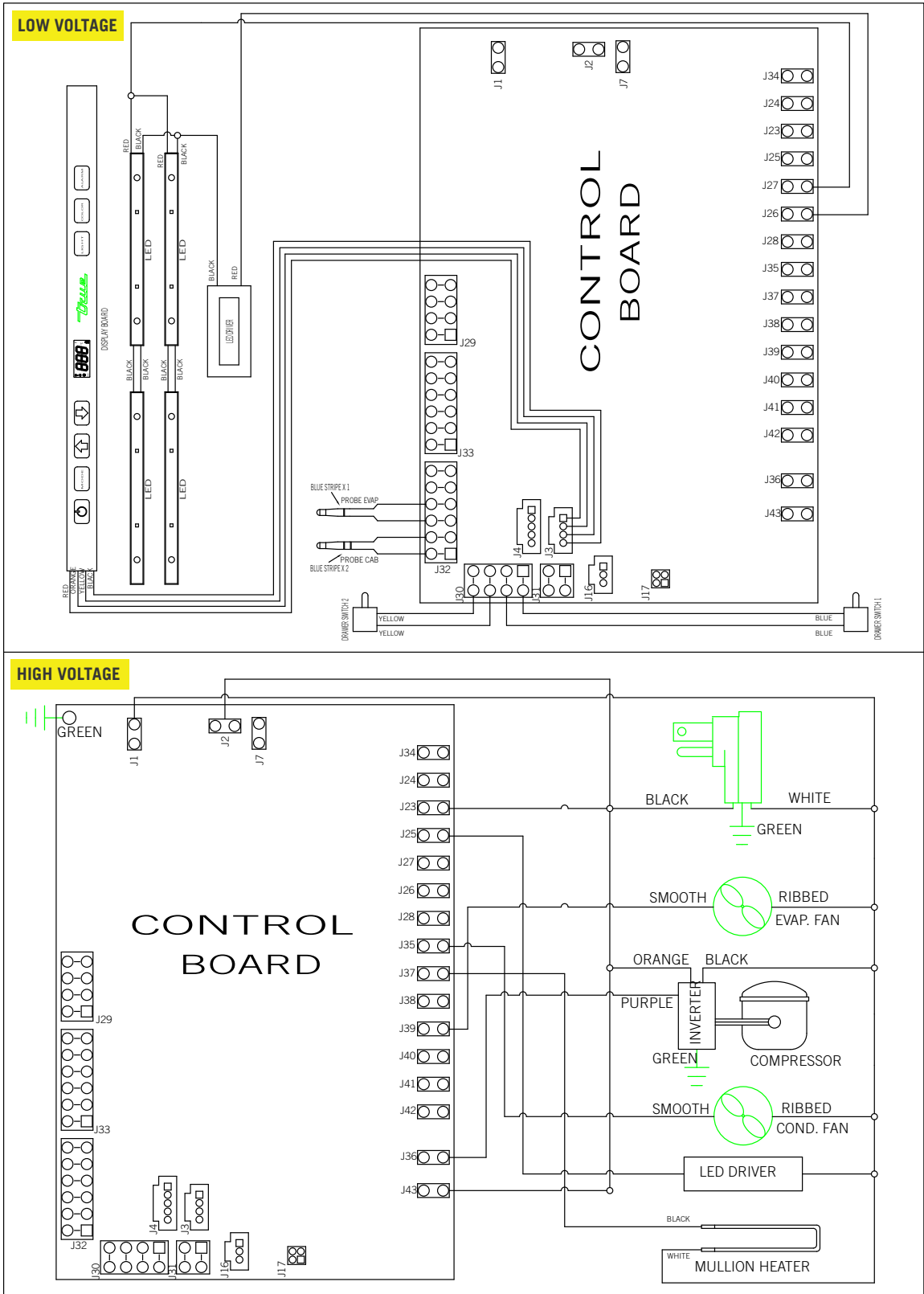

WIRING DIAGRAM

PART NUMBER 957875 TRUE 24" UNDERCOUNTER MODELS

"A" VERSION

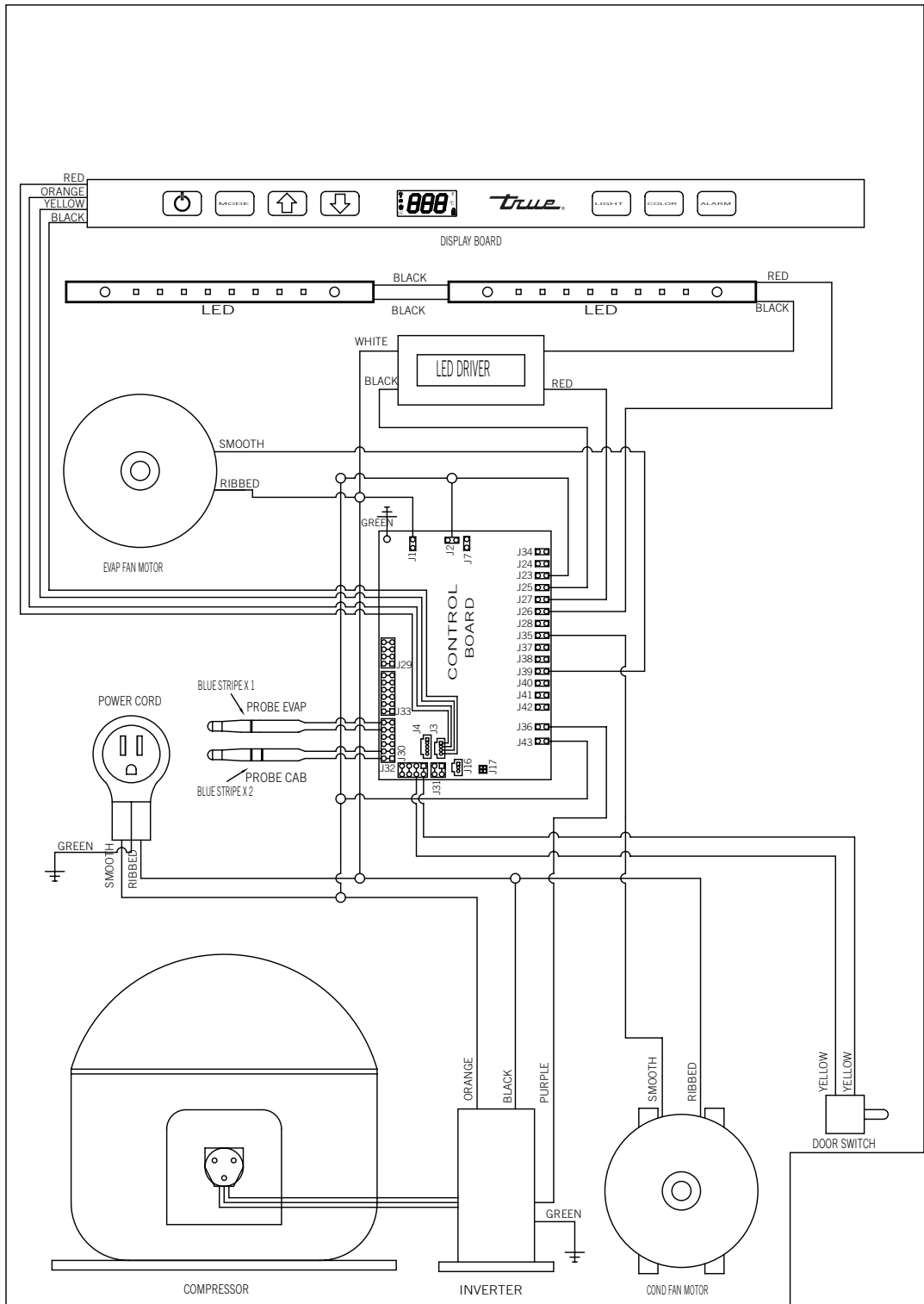

WIRING DIAGRAM
 PART NUMBER 956598
 TRUE 15" UNDERCOUNTER MODELS

"A" VERSION

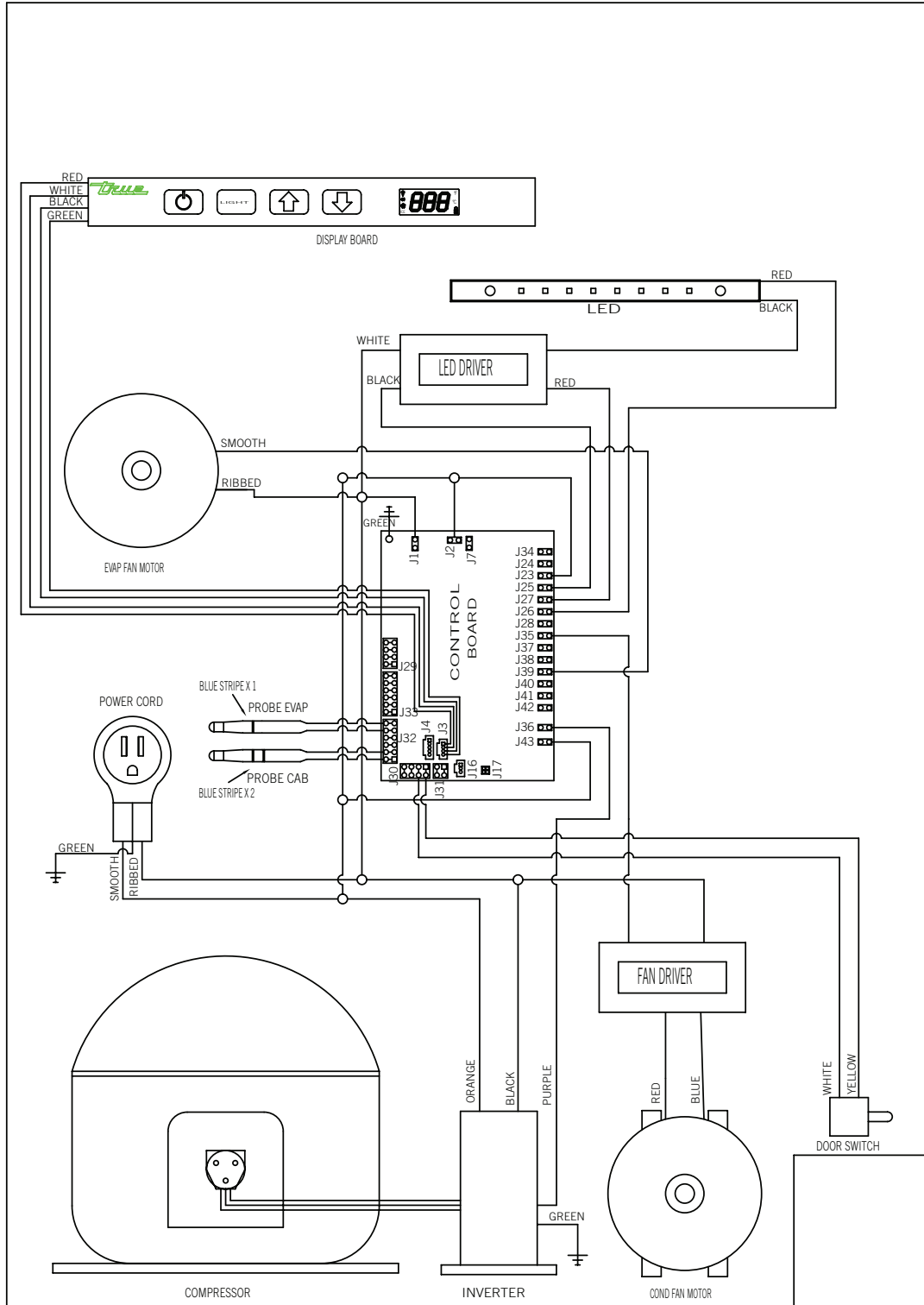

WIRING DIAGRAM
PART NUMBER 956598
TRUE 15" UNDERCOUNTER MODELS

"A" VERSION

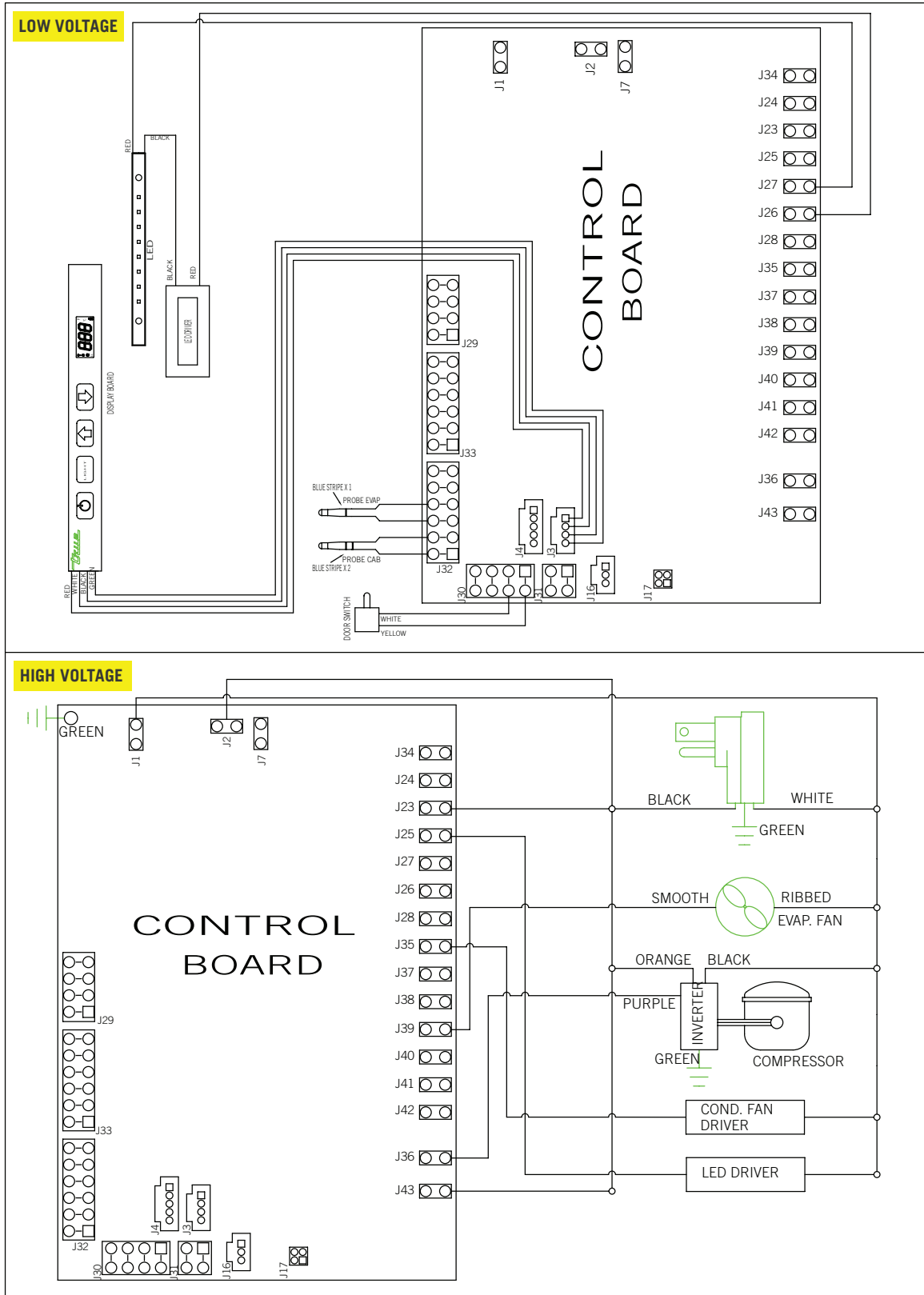

WIRING DIAGRAM

PART NUMBER 982900 TRUE UNDERCOUNTER DRAWERED UNIT

"B" VERSION

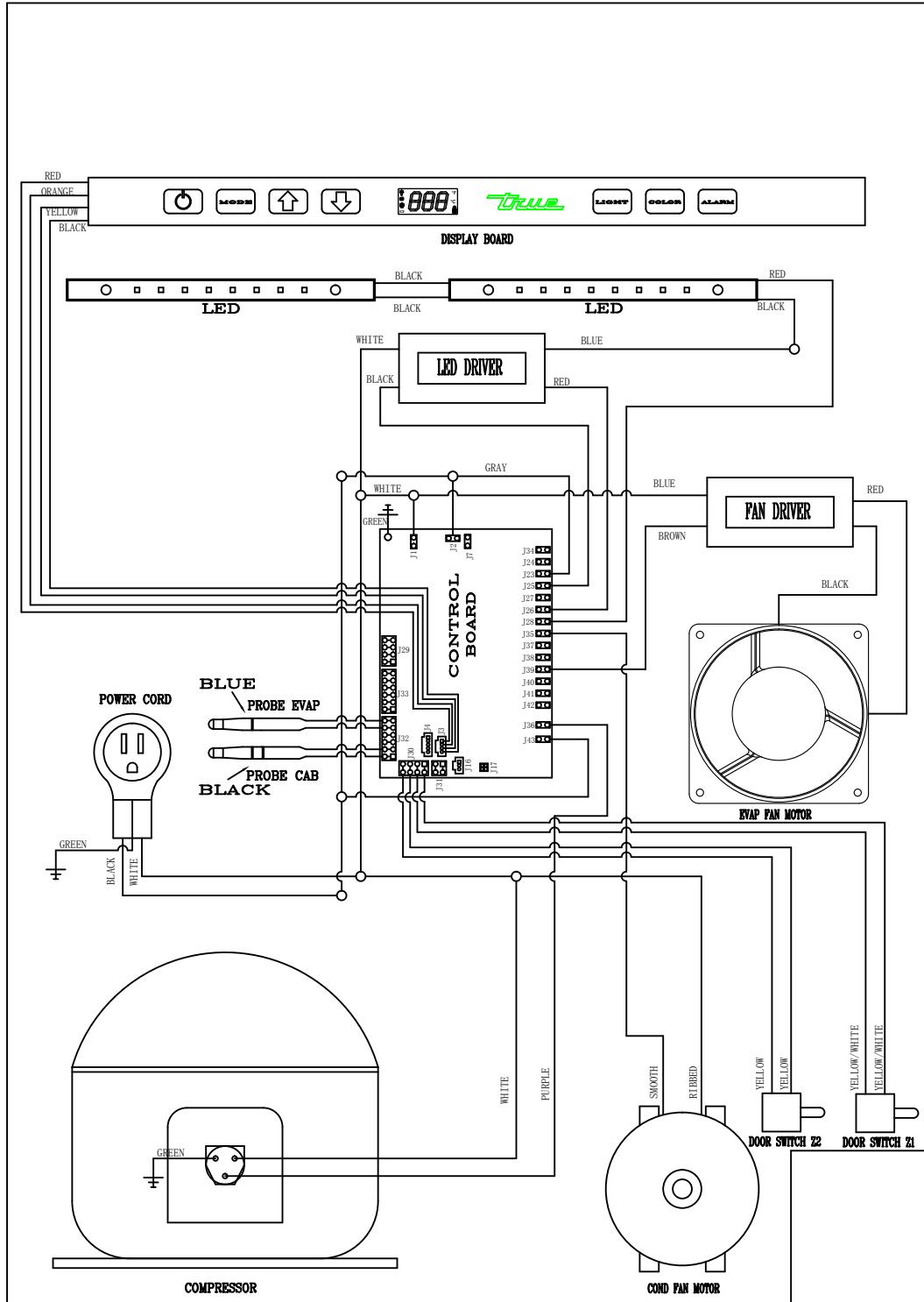

WIRING DIAGRAM

PART NUMBER 980395 TRUE 24" UNDERCOUNTER MODELS

"B" VERSION

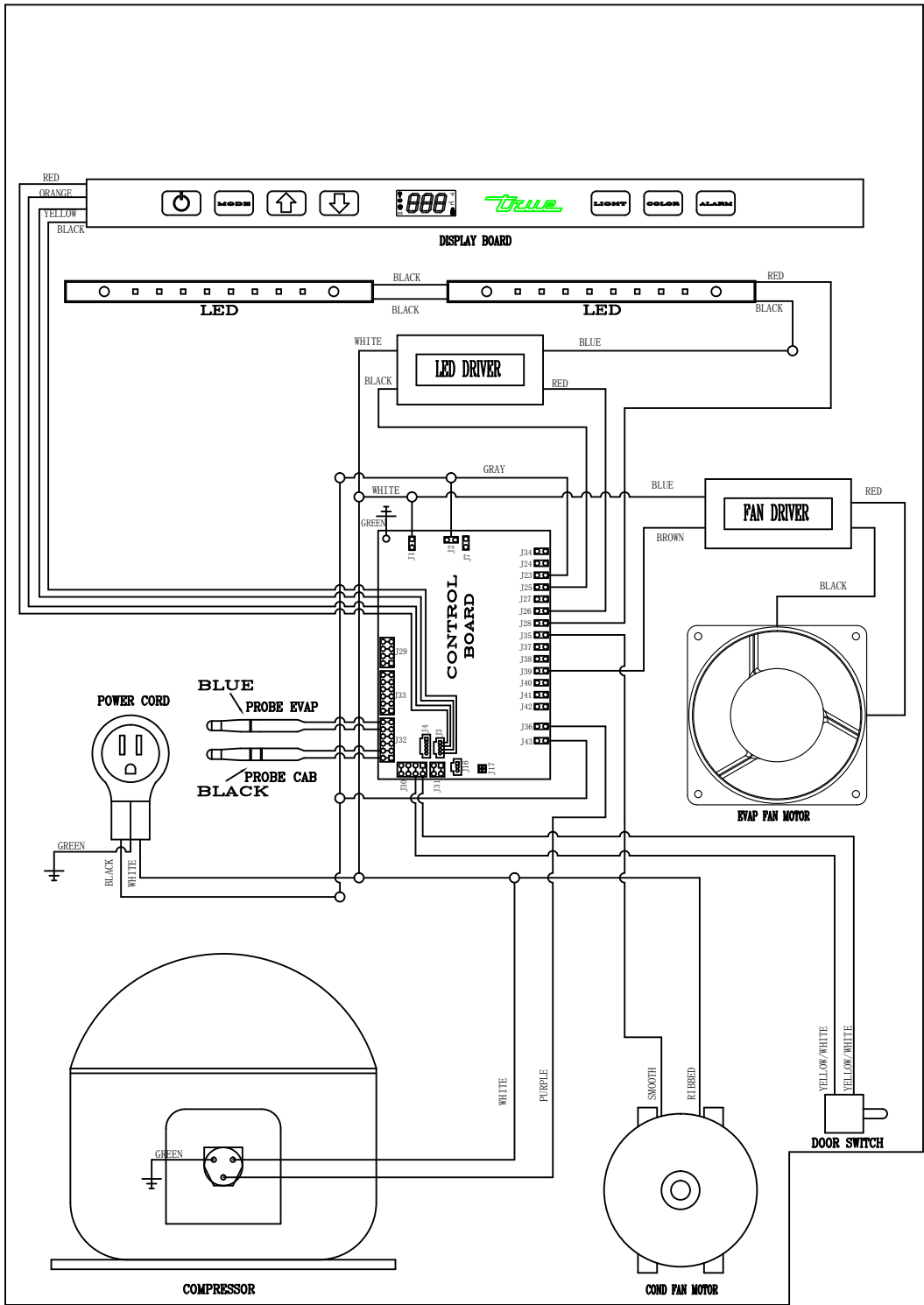

WIRING DIAGRAM

PART NUMBER 982979
TRUE 15" UNDERCOUNTER MODELS

"B" VERSION

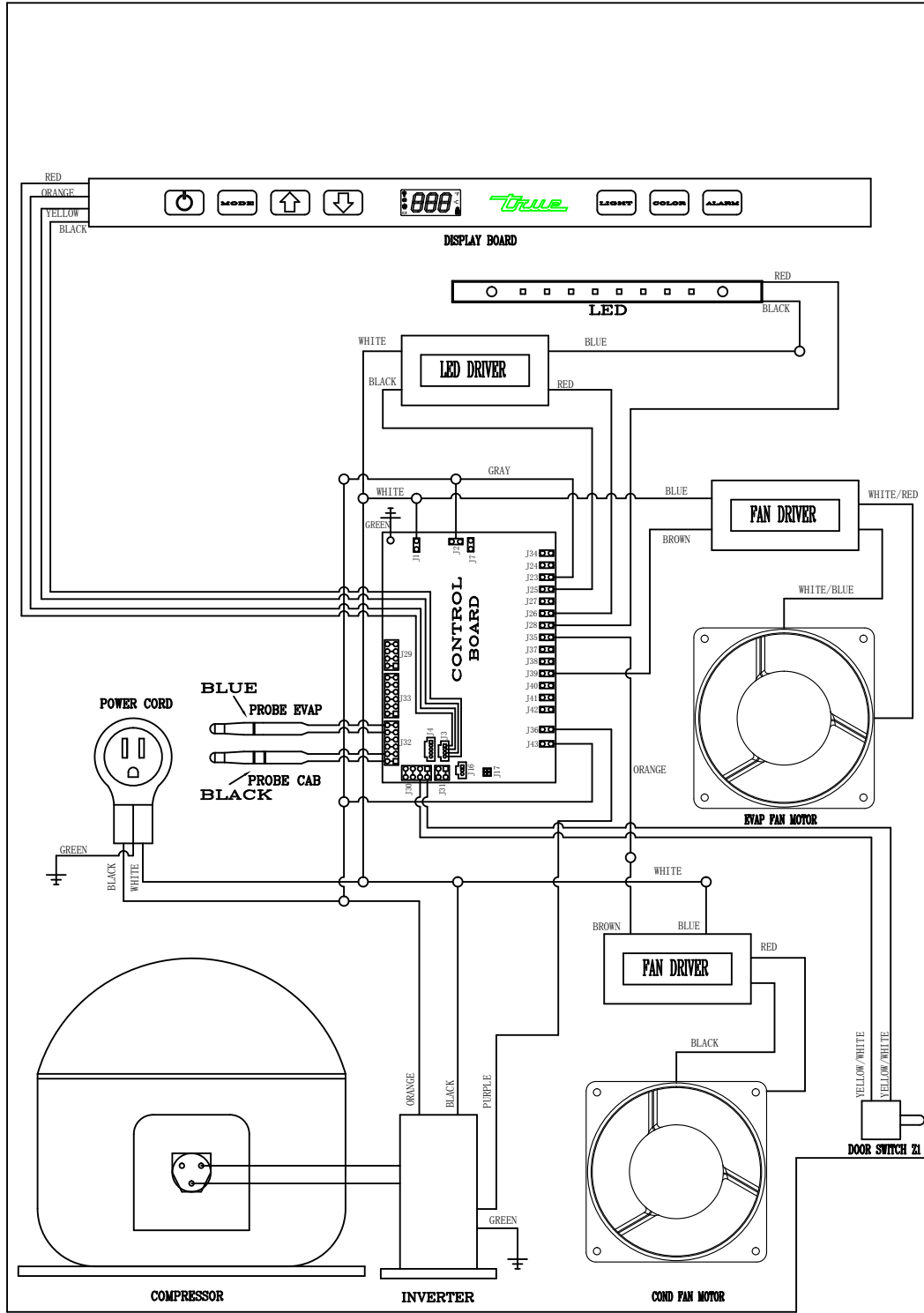

WIRING DIAGRAM

PART NUMBER 952612

TRUE 24" DUAL ZONE WINE CABINET

"A" VERSION

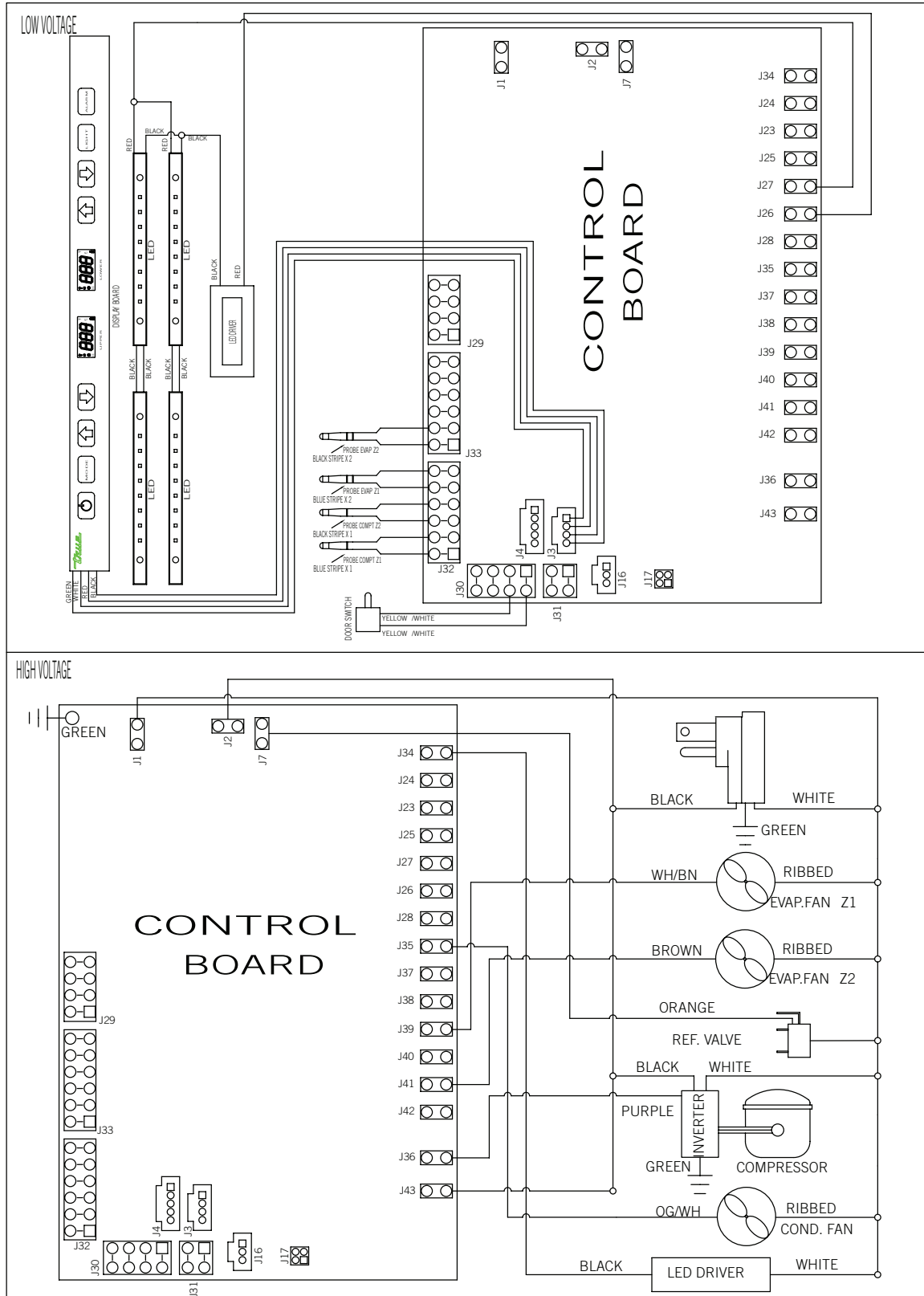

WIRING DIAGRAM

PART NUMBER 988399

TRUE 24" FREEZER

"B" VERSION

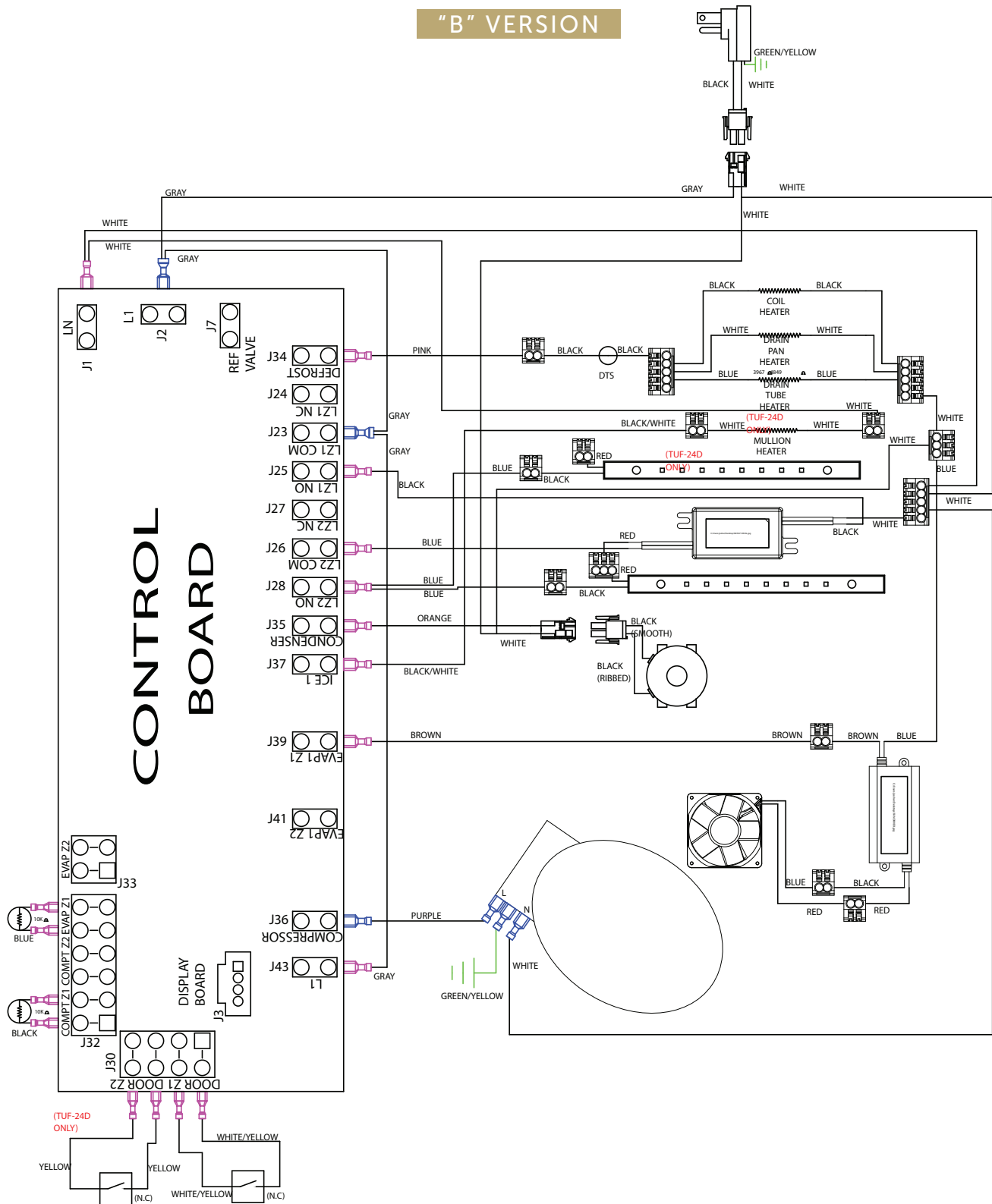

COMPRESSOR INFORMATION

TYPES OF COMPRESSORS AND SPECIFICATIONS

VARIABLE SPEED COMPRESSOR DIAGNOSTICS

INVERTER BOARD DIAGNOSTICS TABLE

COMPRESSOR COMPARTMENT LAYOUT

TYPES OF COMPRESSORS AND SPECIFICATIONS

All "A" version units were equipped with a variable speed compressor.

24 inch "B" version units have a single speed compressor.

15 inch "B" version unit have a variable speed compressor.

The compressor compartment can be accessed by removing the rear panel. This will also gain access to the compressor inverter board and condenser fan motor.

Any time a compressor needs to be changed out, you must go with the OEM compressor that the unit was built with.

We do not recommend going from a single speed to a variable speed or vice versa.

Call Residential Tech support at 844-746-9423 with questions or concerns.

MODELS/VERSIONS	SINGLE SPEED		VARIABLE SPEED
	REFRIGERATOR / WINE	FREEZER	ALL VERSIONS / 15" INCH B VERSIONS
Brand	EMBRACO	EMBRACO	EMBRACO
Model	EM20HSC	EM3D50HLT	VEM Y3H
Nominal Voltage / Frequency	115-127V / 60HZ	115-127V / 60HZ 1 ~	230V / 53-150HZ 3 ~
Refrigerant	R-134A	R-134A	R-134A
Start Device	TSD - 115V	TSD2- 115V	INVERTER
Run Capacitor	5 μ F (175VAC)	15 μ F (200VAC)	N/A
Start Capacitor	N/A	N/A	N/A
Start Winding Resistance	13.18 (Ω at 77°F) +/- 8%	5.92 (Ω at 77°F) +/- 8%	16.07 (Ω at 77°F) +/- 8%
Run Winding Resistance	9.25 (Ω at 77°F) +/- 8%	5.42 (Ω at 77°F) +/- 8%	16.07 (Ω at 77°F) +/- 8%
Locked Rotor Amperage	5.22A	8.0A	N/A
Full Load Amperage	.86A	1.34A	N/A

VARIABLE SPEED COMPRESSOR DIAGNOSIS (SOME MODELS)

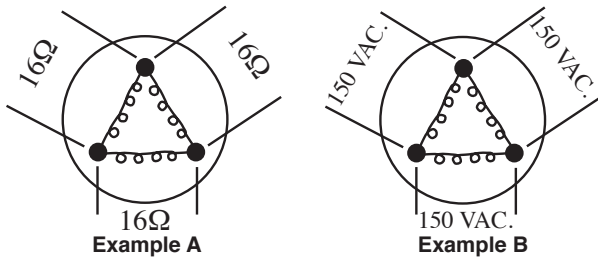

The variable speed compressor is comprised of two components:

1. The inverter board.
2. The compressor.

The compressor speed board is supplied power from the AC line cord. This AC power is converted to DC power on the board. The DC power is sequentially switched to the three motor windings to drive the compressor. By adjusting the speed at which these three windings are switched the speed of the compressor can be adjusted. The switching speed is determined by the amp draw of the compressor. As the load increases the amperage of the compressor goes up the speed board speed up to compensate. As the amperage goes down the speed board will slow the compressor down. The resulting speed will adjust between 4500 rpm and 1600 rpm.

PLEASE NOTE: THE VARIABLE SPEED COMPRESSOR IS A 3 PHASE DC COMPRESSOR APPLYING LINE VOLTAGE TO COMPRESSOR WILL DAMAGE IT.

The VCC looks very similar to a standard single speed compressor. The three terminals on the side of the compressor look the same also. However when taking resistance measurements around the terminals to the outside of the case do not let the different motor design cause confusion. The first check is still to verify that there is NO continuity to the case itself. This is the same as with any standard compressor. When checking between the three terminals, the resistance measurements should be equal regardless of which two terminals you are checking. There are three identical windings attached to these terminals so the resistance of the windings should be equal. It should never read 0 or infinity ohms. With the compressor at 77° the windings will read about 16 ohms each (see example A).

Testing the inverter board:

1. Test for line voltage to the inverter. There should be 120V AC between black and orange wires. If no, check wire harness.
2. Test for signal from temp control board. There should be 120V AC on purple. If no, test the temp control board.

Because of the frequency of the following voltage tests, not all multimeters may be capable of measuring the correct voltage. These tests were made using a good quality multimeter, i.e. Fluke, U.E.I., and Amp Probe brands. The voltage read by your meter will most likely not match the readings made with another meter. The goal is to verify the presence of the drive signals.

3. Test for output voltage of the inverter board. With the leads still attached to the compressor and your meter set for 200V AC, test for voltage between all the windings. If your meter reads 150V, for example, between two windings, it should read 150V between all the rest of the terminals (see example B). If it does not read same voltage at all three windings, suspect the speed board as being faulty.

INVERTER BOARD DIAGNOSTICS TABLE

LED STATUS	LED STATUS DESCRIPTION	
1 FLASH 15 seconds	Normal operation	
2 FLASH 5 seconds	Control communication problem.	<ul style="list-style-type: none"> • Pull down cycle - if inverter doesn't sense the thermostat signal for 10 minutes. • Normal cycle - if inverter doesn't receive the thermostat signal for 4 hours
3 FLASH 5 seconds	VCC inverter problem.	<ul style="list-style-type: none"> • Some problem on the inverter hardware
4 FLASH 5 seconds	VCC compressor problem.	<ul style="list-style-type: none"> • Is not possible to keep the speed over 1,600 rpm in an overload or overvoltage situation • Inverter is reaching the max power even at the minimum speed (1,600 rpm) • Starting fail • Rotor position fail • Over 221°F internal inverter temperature
1 FLASH	Temperature protection activated.	<ul style="list-style-type: none"> • Over 203°F internal inverter temperature • Power limit decreases to protect the inverter

NOTE: PRIOR TO CONDEMING THE INVERTER BOARD. OHM THE COMPRESSOR OUT TO MAKE SURE IT'S NOT SHORTED TO GROUND NOR HAS AN OPEN WINDING.

COMPRESSOR COMPARTMENT LAYOUT

“A” VERSION

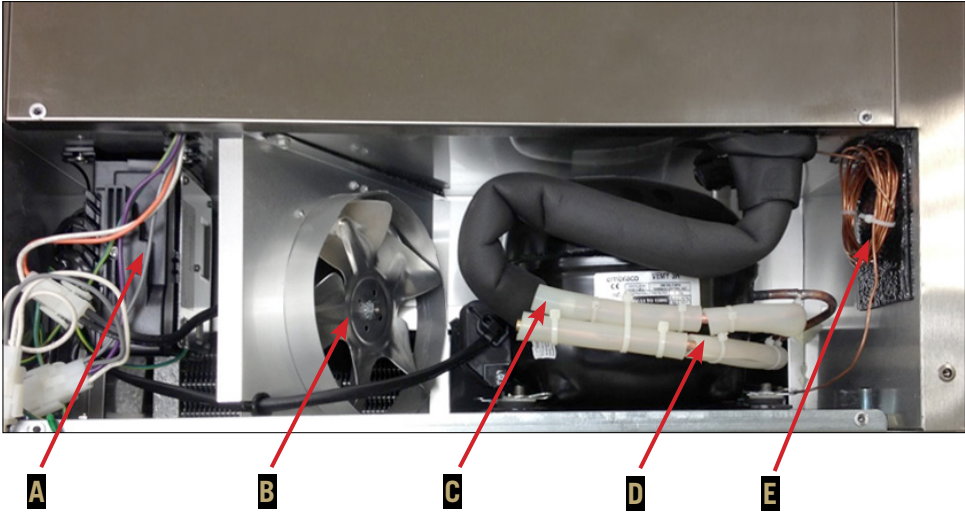

- A. Inverter Board
- B. Condenser Fan Motor
- C. Low Side Process Tube
- D. High Side Process Tube
- E. Cap Tube

“B” VERSION

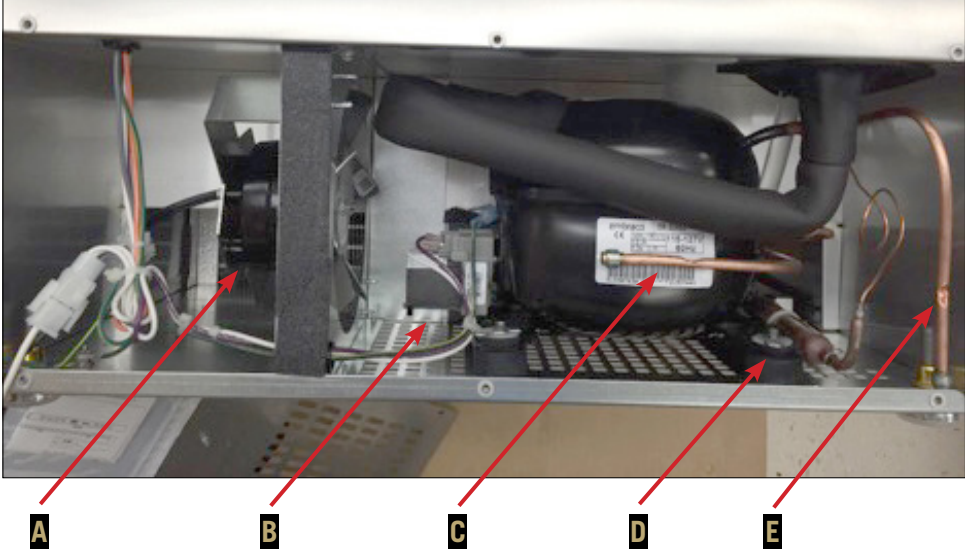

- A. Condenser Motor
- B. Start Components
- C. High Side Process Tube
- D. Liquid Line Filter Drier
- E. Low Side Process Tube

15 INCH VERSION



- A. Inverter Board
- B. Condenser Fan Motor
(located behind inverter board)
- C. High Side Process Tube
- D. Cap Tube
- E. Low Side Process Tube

SEALED SYSTEM

GOOD REFRIGERATION PRACTICES

SYSTEM PRESSURES

TROUBLESHOOTING, REPAIRS & REPLACEMENT



GOOD REFRIGERATION PRACTICES

GOOD REFRIGERATION PRACTICES WILL ALWAYS START WITH GOOD DETECTIVE WORK TO FIND OUT WHAT CAUSED THE FAILURE SO WE CAN ELIMINATE THE POSSIBILITY OF A REPEAT FAILURE. BELOW IS A STEP BY STEP SET OF PROCEDURES WE WOULD RECOMMEND IS FOLLOWED WHEN REPAIRING A REFRIGERATION SYSTEM.

- Before opening the refrigeration system remember that POE oil is very hygroscopic and absorbs moisture very quickly. You should not leave the system open to the atmosphere for more than 15 minutes. Any vacuum that exists before any repair should be broken with nitrogen to avoid moisture being pulled into the system.
- For your manifold gauges, use as short of refrigeration hoses as possible. We recommend maximum of 12" (304.8 mm) hoses.
- Always replace the drier with the exact OEM size when opening the refrigeration system.
- Recover the refrigerant from the system.
- The introduction to the refrigeration system of anything other than a flushing agent, nitrogen, refrigerant, or oil is prohibited.
- Remove the faulty refrigeration component and filter drier by cutting them out with a tubing cutter.
- If you are changing a component keep the system closed up with plugs or caps to reduce moisture contamination.
- Take a look at the filter drier and the components that have been removed for signs of oil breakdown, foreign objects like desiccant from drier, metal pieces from valves, etc.
- When replacing a compressor make sure to also remove all old oil from the system.
- While purging nitrogen through the system drill (approximately 1/8") (3.18 mm) hole in the bottom of the accumulator (IF EQUIPPED) so we do not leave contaminated oil in the system. After blowing this out with nitrogen, be sure to braze the hole closed.
- Be sure and test the oil from the refrigeration system for contamination using the proper test kit for the type of oil.
- If the oil shows signs of contamination or there was a restriction in the system, all of the oil must be removed and replaced. This can be accomplished by removing the compressor and flushing the entire system with nitrogen. Remove all the oil in the compressor, and in the accumulator. Measure all the old oil in a measuring cup and replace the exact amount you removed with the new oil. If necessary, a flushing agent can be used for cleanup.
- Place a nitrogen charge in the system to check for any leaks. Use maximum 200 PSI (13.8 Bar).
- Release the nitrogen charge down to about
- 2 pounds of positive pressure (.1379 bar).
- Start pulling a vacuum as soon as possible to help remove any moisture from the system. Remember that any moisture that is absorbed by the POE oil cannot be removed and we must start the process over.
- Change vacuum pump oil regularly to ensure the deepest vacuum your pump is capable of.
- Using a micron gauge, pull the system down to hold a minimum of 500 microns (0.5 Torr).
- See if the system will hold this micron with the gauges closed and the pump switched off to test for leaks or moisture.
- Once the system is evacuated, weigh in the listed refrigerant charge located on the serial tag inside the cabinet. Refrigerant 134a/404A charge as a liquid only. Refrigerant should be charged through the high side.
- Test run the unit and check for proper operation.

AFTER REPAIR IS COMPLETE ALL ACCESS FITTINGS MUST BE REMOVED.

PLEASE CALL TRUE TECHNICAL SERVICE WITH ANY QUESTIONS REGARDING THE ABOVE PRACTICES.

SYSTEM PRESSURES

- Ambient Temperature + 15° = Saturation pressure for that temperature. This High Side Pressure will be +/- 5 psig.
- Cabinet / zone Temperature -20 degrees = Saturation pressure for that temperature. This Low Side Pressure will be +/-3 psig.

NOTE: FOR MOST ACCURATE RESULTS, TAKE READING WHEN CABINET IS RUNNING AND NEAR CUT OUT TEMPERATURES.

TROUBLESHOOTING THE REFRIGERATION SYSTEM

DO NOT CUT OFF PROCESS TUBE ENDS - Using piercing type service valves, attach one of these to each of the suction and liquid line process tubes (as close to the end of the tube as possible).

MAKE SURE THE GAUGES YOU ARE USING ARE CALIBRATED AND CORRECTLY INSTALLED.

After connecting your gauges - make sure you confirm the compressor is running when doing the next diagnostic checks.

BAD COMPRESSOR VALVES

If your system has a high suction pressure and low discharge pressure and the compressor is drawing low amps its very likely you have a compressor with bad valves. If this is the case, replace the compressor.

DETERMINE LEAK OR RESTRICTION

If your system has a low suction pressure and low discharge pressure, first look to see if there are no visible kinks in the system tubing, then recover the refrigerant and weigh in the correct charge.

- A. If your evaporator coil temperature drops and the system starts to operate correctly this is a sign that your system has a refrigerant leak. This means that the refrigerant leak must be located and repaired. A technician can raise system pressure up 200 psi with nitrogen to aid in the leak search.
- B. If the head pressure rises but falls right back down after you stop adding gas and the suction pressure stays low there may be a restriction in the system. Recover the charge and cut out the drier. Also cut about 2" off of the capillary tube. Circulate nitrogen through the system to clear any restrictions in the evaporator. Evacuate the system and recharge. If the problem still exists, capillary tube may need to be replaced.

***EACH TIME A SYSTEM IS TAPPED INTO, IT IS VERY IMPORTANT THAT THE DRIER IS REPLACED AND A MINIMUM 500 MICRON VACUUM IS PULLED THROUGH BOTH HIGH AND LOW SIDE ACCESS FITTINGS. AFTER THE SYSTEM IS RECHARGED BOTH ACCESS FITTINGS MUST BE REMOVED.**

REPLACING THE COMPRESSOR

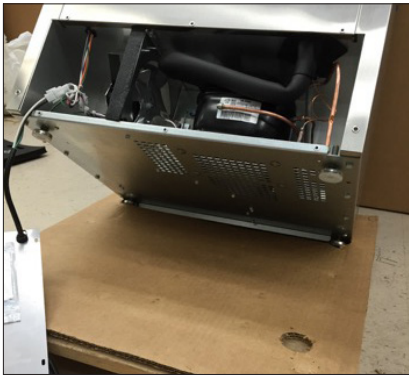

FIGURE 1

1. Tape front door closed. Lean front of cabinet against wall or something as stable. Cover front of cabinet to keep from damaging wall or cabinet. Remove rear cover. Rest unit against the wall and remove the back and bottom of the unit.



FIGURE 2

2. Reclaim per EPA standards. Cut suction line just above joint (figure 2). Rotate suction line attached to compressor out of the way. Disconnect liquid line.

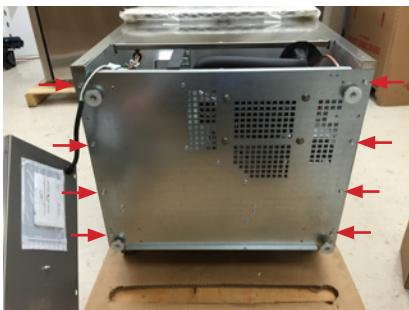

FIGURE 3

3. Remove (4) 3/8" bolts from both left and right of the bottom panel (figure 3). Insert a 2x2 to hold bottom down (figure 4). Remove the pull pins located on each bolt of the compressor legs. Pull compressor up to clear bolts and pull out. With compressor removed change drier. Reinstall compressor in reverse order.



FIGURE 4

***A 500 MICRON VACUUM MUST BE PULLED AND CHARGE WEIGHT BACK IN.**

REPLACING THE CONDENSER COIL

Repeat steps 1 & 2 of Replacing the Compressor.

Remove the four 3/8" bolts on the left and right side of the cabinet base securing the bottom plate of unit. Pull compressor and condenser coil out as a unit. Replace coil and drier. Reinstall bottom plate in reverse order. (figure 3)

*** A 500 MICRON VACUUM MUST BE PULLED AND CHARGE WEIGHT BACK IN.**

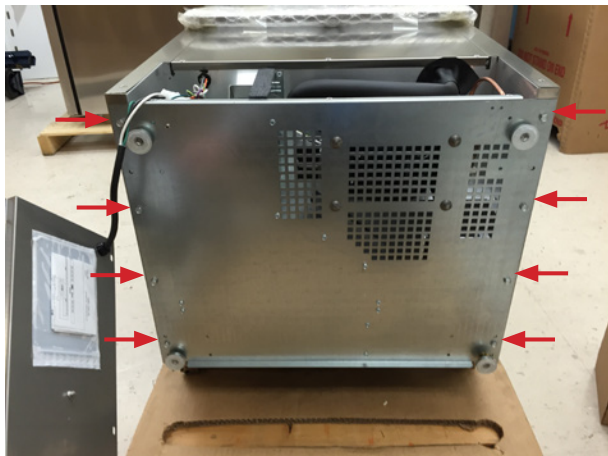

FIGURE 3

REPLACING THE CAP TUBE

Remove evaporator cover un-braze cap tube from evaporator coil. Remove compressor as earlier indicated. Cut connection at liquid line and drier. Pull cap tube down and through hole of cabinet floor. Install new drier and cap tube at drier end. Reroute cap tube into cabinet and braze into evaporator coil. Reinstall compressor.

*** A 500 MICRON VACUUM MUST BE PULLED AND CHARGE WEIGHT BACK IN.**

REPLACING THE EVAPORATOR COIL

Remove evaporator cover (see probe replacement). Un-braze suction and cap joints at evaporator. Remove evaporator coil. Remove compressor (see compressor replacement). Replace drier filter. Install evaporator coil. Re-braze fittings.

*** A 500 MICRON VACUUM MUST BE PULLED AND CHARGE WEIGHT BACK IN.**

LEAK CHECK GUIDELINES

True Manufacturing recommends to leak check a unit by using a trace amount of refrigerant and charging the system with nitrogen to 200 psi (not to exceed 220). If leak is not located by this method, then True Manufacturing recommends that the low side be separated by the high side. Charge both sections with nitrogen at 200 psi and see which side does not hold.

SYSTEM EVACUATION

Any time a system is open, True Manufacturing expects the drier to be changed, the system vacuumed down to 500 microns or lower and the refrigerant charged weight in.

MAINTENANCE

STAINLESS STEEL CARE AND CLEANING

GASKET CLEANING

GENERAL MAINTENANCE,

WARRANTY



STAINLESS STEEL EQUIPMENT CARE AND CLEANING

CAUTION: DO NOT USE ANY STEEL WOOL, ABRASIVE OR CHLORINE BASED PRODUCTS TO CLEAN STAINLESS STEEL SURFACES.

STAINLESS STEEL OPPONENTS

There are three basic things which can break down your stainless steel's passivity layer and allow corrosion to rear its ugly head.

1. Scratches from wire brushes, scrapers, and steel pads are just a few examples of items that can be abrasive to stainless steel's surface.
2. Deposits left on your stainless steel can leave spots. You may have hard or soft water depending on what part of the country you live in. Hard water can leave spots. Hard water that is heated can leave deposits if left to sit too long. These deposits can cause the passive layer to break down and rust your stainless steel.
All deposits left from food prep or service should be removed as soon as possible.
3. Chlorides are present in table salt, food, and water. Household and industrial cleaners are the worst type of chlorides to use.

RECOMMENDED CLEANERS FOR CERTAIN SITUATIONS / ENVIRONMENTS OF STAINLESS STEEL

- A. Soap, ammonia and detergent medallion applied with a cloth or sponge can be used for routine cleaning.
- B. Arcal 20, Lac-O-Nu Ecoshine applied provides barrier film for fingerprints and smears.
- C. Cameo, Talc, Zud First Impression is applied by rubbing in the direction of the polished lines for stubborn stains and discoloring.
- D. Easy-off and De-Grease It oven aid are excellent for removals on all finishes for grease-fatty acids, blood and burnt-on foods.
- E. Any good commercial detergent can be applied with a sponge or cloth to remove grease and oil.
- F. Benefit, Super Sheen, Sheila Shine are good for restoration / passivation.

NOTE: THE USE OF STAINLESS STEEL CLEANERS OR OTHER SUCH SOLVENTS IS NOT RECOMMENDED ON PLASTIC PARTS. WARM SOAP AND WATER WILL SUFFICE.

8 STEPS THAT CAN HELP PREVENT RUST ON STAINLESS STEEL:

1. USING THE CORRECT CLEANING TOOLS

Use non-abrasive tools when cleaning your stainless steel products. The stainless steel's passive layer will not be harmed by soft cloths and plastic scouring pads. Step 2 tells you how to find the polishing marks.

2. CLEANING ALONG THE POLISH LINES

Polishing lines or "grain" are visible on some stainless steels. Always scrub parallel to visible lines on some stainless steels. Use a plastic scouring pad or soft cloth when you cannot see the grain.

3. USE ALKALINE, ALKALINE CHLORINATED OR NON-CHLORIDE CONTAINING CLEANERS

While many traditional cleaners are loaded with chlorides, the industry is providing an ever increasing choice of non-chloride cleaners. If you are not sure of your cleaner's chloride content contact your cleaner supplier. If they tell you that your present cleaner contains chlorides, ask if they have an alternative. Avoid cleaners containing quaternary salts as they can attack stainless steel, causing pitting and rusting.

4. WATER TREATMENT

To reduce deposits, soften the hard water when possible. Installation of certain filters can remove corrosive and distasteful elements. Salts in a properly maintained water softener can be to your advantage. Contact a treatment specialist if you are not sure of the proper water treatment.

5. MAINTAINING THE CLEANLINESS OF YOUR FOOD EQUIPMENT

Use cleaners at the recommended strength (alkaline chlorinated or non-chloride). Avoid build-up of hard stains by cleaning frequently. When boiling water with your stainless steel equipment, the single most likely cause of damage is chlorides in the water. Heating any cleaners containing chlorides will have the same damaging effects.

6. RINSE

When using chlorinated cleaners you must rinse and wipe dry immediately. It is better to wipe standing cleaning agents and water as soon as possible. Allow the stainless steel equipment to air dry. Oxygen helps maintain the passivity film on stainless steel.

7. HYDROCHLORIC ACID (MURIATIC ACID) SHOULD NEVER BE USED ON STAINLESS STEEL

8. REGULARLY RESTORE/PASSIVATE STAINLESS STEEL

GASKET CLEANING

CLEAN THE DOOR GASKET BY FOLLOWING THESE STEPS:

1. Turn the unit off.
2. Use a mild detergent and water with a soft cloth. Water and baking soda paste may be used to remove tough stains.
3. Use a 1:10 part ratio of bleach to water and a soft cloth to wipe down the interior and affected areas if mold or mildew are present.
4. Rinse and dry thoroughly.

GENERAL MAINTENANCE

Keeping the condenser coil clean will minimize required service and lower electrical cost. The condenser coil is accessible from the front.

The condenser coil should be cleaned by removing dust and other build-up from the tube assembly with vacuum or a cleaning rag.

When properly cleaned you should be able to see through the tube assembly.

Warranty does not cover cleaning the condenser coil.

TRUE RESIDENTIAL® SERIES LIMITED WARRANTY STATEMENT

LIMITED 30 DAY COSMETIC WARRANTY

Stainless steel doors, handles, and shelves are warranted to be free from defective materials or workmanship for a period of thirty (30) days from the date of original retail purchase. Any defects must be reported to the selling dealer within thirty (30) days from the date of original retail purchase. This limited warranty excludes any type of freight / concealed damage.

THREE-YEAR PARTS & LABOR WARRANTY *For units purchased after Feb 1, 2013.

TRUE warrants to the original purchaser of every new TRUE refrigerated unit, the cabinet and all parts thereof, to be free from defects in material or workmanship under normal and proper use and maintenance as specified by TRUE and upon proper installation and start-up in accordance with the instruction packet supplied with each TRUE unit. TRUE's obligation under this warranty is limited to a period of three (3) years from the date of original installation or thirty nine (39) months after shipment date from TRUE, whichever occurs first.

SIX-YEAR SEALED SYSTEM WARRANTY - PARTS & LABOR *For units purchased after Feb 1, 2013.

TRUE warrants its hermetically sealed system: compressor, evaporator coil, condenser coil, drier, metering device and connecting tubing to be free from defects in both material and workmanship under normal and proper use and maintenance service for a period of six (6) years from the date of original installation but not to exceed six (6) years and three (3) months after shipment from the manufacturer, whichever occurs first.

SEVEN THROUGH TWELVE-YEAR SEALED SYSTEM WARRANTY - PARTS ONLY *For units shipped from True after Feb 1, 2017 and REGISTERED via True's Product Registration Page – TRUE warrants its hermetically sealed system: compressor, evaporator coil, condenser coil, drier, metering device and connecting tubing to be free from defects in both material and workmanship under normal and proper use and maintenance service period of Twelve (12) years from the date of original installation but not to exceed twelve (12) years and three (3) months after shipment from the manufacturer, whichever occurs first. Product must be registered with True to qualify for this warranty. Factory seconds and clear Ice machines are excluded from this warranty.

TERMS APPLICABLE TO EACH WARRANTY

Any part covered under the above warranties that is determined by TRUE to have been defective within the time frame is limited to the repair or replacement, including labor charges, of defective parts or assemblies. The labor warranty shall include standard straight time labor charges only and reasonable travel time, as determined by TRUE.

WARRANTY CLAIMS

All claims for labor or parts must be made directly through TRUE. All claims should include: model number and serial number of cabinet, proof of purchase, and date of installation. In case of warranted compressor, the compressor model tag must be returned to TRUE along with the above listed information.

WHAT IS NOT COVERED BY THIS WARRANTY

TRUE's sole obligation under this warranty is limited to either repair or replacement of parts, subject to the additional limitations below. This warranty neither assumes nor authorizes any person to assume obligations other than those expressly covered by this warranty.

NO CONSEQUENTIAL DAMAGES. TRUE is not responsible for economic loss, profit loss; or special, indirect or consequential damages, including without limitation, losses or damages arising from food or product spoilage claims whether or not on account or refrigeration failure.

WARRANTY IS NOT TRANSFERABLE. This warranty is not assignable and applies only in favor of the original purchaser/user to whom delivered. Any such assignment or transfer shall void the warranties herein made and shall void all warranties, express or implied, including any warranty or merchantability or fitness for a particular purpose.

IMPROPER USAGE. TRUE assumes no liability for parts or labor coverage for component failure or other damages resulting from improper usage or installation or failure to clean and/or maintain product as set forth in the warranty packet provided with the unit.

ALTERATION OR NEGLIGENCE. TRUE is not responsible for the repair or replacement of any parts that TRUE determines have been subjected after the date of manufacture to alteration, neglect, abuse, misuse, accident, damage during transit or installation, fire, flood, or act of God.

IMPROPER ELECTRICAL CONNECTIONS. TRUE is not responsible for the repair or replacement of failed or damaged components resulting from electrical power failure, high or low voltage, use of extension cords, or improper grounding of the unit.

YOUR RIGHTS UNDER STATE LAW.

This warranty gives you specific legal rights and you may have other rights that vary from state to state. Some states do not allow the exclusion or limitation of consequential damages or a limitation on how long an implied warranty lasts, so the above exclusion or limitation may not apply to you.

OUTSIDE U.S./CANADA. This warranty does not apply to, and TRUE is not responsible for, any warranty claims made on products sold or used outside the United States or Canada.

SUBMIT WARRANTY CLAIMS TO: **True Residential**
2001 East Terra Lane
O'Fallon MO 63366
TrueResidentialWarranty@truemfg.com

CONTACT US

www.true-residential.com

(636)240-2400 • toll free (888)616-8783

